



Project 5 Final Report

Rope-less Fishing Technology Development

Jim Partan and Keenan Ball

jpartan@whoi.edu, kball@whoi.edu

Department of Applied Ocean Physics and Engineering

Woods Hole Oceanographic Institution

Woods Hole, MA 02543

Abstract: This technical report describes the design and fabrication of prototype rope-less fishing systems. The prototypes consist of new designs intended as a contribution towards evaluating the potential of rope-less fishing in the Gulf of Maine offshore lobster fishery. Three prototype units were fabricated for use in future testing.

Rope-less fishing gear has long been discussed as a possible approach to reducing entanglement of North Atlantic Right whales, other marine mammals, and sea turtles. A rope-less system secures the vertical lines of fixed fishing gear on the seafloor until they are released to the surface for hauling.

The focus of this project was on the offshore fishery for several reasons: (1) Previous demonstrations of rope-less fishing gear were not designed to operate in the high currents and deep water of the offshore New England and Gulf of Maine lobster fishery; (2) Weak links and ropes of reduced breaking strength are not likely to be viable for the large and heavy trawls of up to fifty traps that are used offshore; and (3) While lobster fishing gear in general is a major source of entanglements, heavier gear such as that used in the offshore fishery appears to present a larger risk for North Atlantic Right whales.

Design requirements were derived from discussions with offshore fishermen and previous studies of rope-less gear. The offshore lobster fishery has water depths up to 300 meters, and surface currents of up to 1-2 knots. Line scopes will need to be between 2:1 and 3:1, with about 140-180 pounds of buoyancy in order to bring the line to the surface. To be compatible with existing hauling equipment, gear weights, and dimensions on offshore fishing vessels, design requirements included a unit that could be used with a line diameter of at least ½", has a maximum weight of about 180 pounds, and a maximum length of about four feet.

To secure the line on the seafloor, the prototype uses a line spool with capacity for 900 meters of ½" line. Flotation foam provides 180 pounds of buoyancy in the spool. The release is controlled by a timer with a release time set by the user, providing a cost-effective means (relative to acoustic releases) to reduce the time of exposure of vertical lines in the water column to marine animals. The design is modular to allow scaling to different fishing environments, such as shallower inshore waters.

This study also performed a preliminary investigation of passive acoustic detectability of rope-less fishing gear. Without surface buoys, an alternate method for detecting rope-less gear is needed to reduce gear conflicts with other fixed gear as well as mobile gear. Extrapolating the results of an echo-sounder dock test in 14 meters to 300 meters depth will be somewhat inconclusive. Echo-sounder detection of the rope-less endline spools in 300 meters is likely feasible, but distinguishing passive acoustic reflectors on lobster traps from the seafloor will likely be challenging with standard echosounders.

This study fabricated three prototype rope-less fishing gear units. The next steps are continued testing to validate robust unspooling, followed by testing in collaboration with operational fishing vessels.

Funding Acknowledgement: This investigation was supported by The Consortium for Wildlife Bycatch Reduction at the New England Aquarium under NOAA / NMFS Grant Award NA10NMF4520343.

Section 1: Operational Information Derived from Offshore Fishing Vessels

An excellent summary of lobster pot gear configurations, as deployed in the water, is provided in the report “Lobster Pot Gear Configurations in the Gulf of Maine” (McCarron and Tetreault, 2012). That report does not cover deck operations on offshore lobster boats, however. To understand compatibility with existing deck operations and deck equipment of offshore vessels, we visited two lobster boats in July 2015. One of the boats operates near a potential Gear Development Area--that have been discussed previously for offshore areas such as the Great South Channel Restricted Area (NMFS, 2010)--and the other was nominally an inshore boat, but fishes trawls of up to 20 traps about 20 miles offshore. Every fisherman operates slightly differently, and we describe the operations of these two particular boats in the sections below.

Section 1.1: Offshore Boat operating near potential offshore Gear Development Area

The offshore boat we visited is 75' long and has a crew of four plus a captain. Offshore boats in similar waters can be up to about 90' long. Two boats under the same ownership partnership service 1600 traps, set in 50-trap trawls. They spend 3-4 days at sea per trip, and fish primarily along the 100-fathom line (200 meter bathymetry line) near the Continental Shelf break, from Hydrographer's Canyon in the west to the Hague Line in the east, and in particular east of Oceanographer's Canyon where the fishing is apparently better. Traps are set for about 3-7 days, depending upon the season. They haul 10-15 trawls per day. They operate 24 hours per day when at sea. In addition to lobster, the boat fishes for Jonah crabs with essentially the same gear.

There is a vertical line, 5/8", with buoys on each end of the trawl. The buoys on this boat were two LD-3 Polyform floats (40.7 liters each, about 91 pounds rated buoyancy each) on each of the vertical lines. The high-flier with radar reflector was not always used, especially when currents were high, because it could get dragged under, the foam buoy crushed, and then sink the vertical line. The pair of LD-3 Polyform floats on each vertical line sometimes gets dragged under as well, but not deep enough to crush the floats.

Trawls generally are set “downhill” (with the tide), and generally hauled “uphill” (into the tide). That is the main reason that there is a vertical line on both ends of the trawl. If the tidal current is strong, the buoys can be pulled under, and they have to wait until the tide slackens to haul.

During hauling operations, the gear comes through a small door/opening in the rail and onto the deck, through a pot hauler. The hauler plates get worn out frequently due to sediment in the sinking groundlines, and need to be re-planed every few trips. It takes about an hour to haul a trawl of 40-50 traps. As the trawl is hauled, the traps are stacked on deck, and the line goes into a line locker (example size: 4' x 6' x 6' high). There can be a crew member assigned to the line locker to make sure the line goes in neatly. That particular size line locker can fit lines for about three trawls if they are packed neatly. After

the entire trawl is recovered on deck, it is redeployed, generally in the same location if the fishing was good.

The offshore traps each weight about 100 pounds when empty. At each end of the trawl is a 180-pound “anchor sled” made of steel. The vertical lines are put together of 50-fathom (100-meter) shots, with a big knot joining the shots. Some fishermen use 75-fathom (150-meter) shots. In 100-fathom (200-meter) water depths, the vertical lines are 175-300 fathoms (350-600 meters).

Due to chafing of the sinking groundlines, in particular with storms, sometimes trawls or parts of trawls are lost. If a trawl is lost, they will grapple for it. They can sometimes see the vertical line on the echo sounder (Furuno FCV-292).

The gear conflict between fixed-gear fishermen and dragger mobile-gear fishermen is in part dealt with through what appears to be an historical informal agreement: Fixed gear is set on certain LORAN time-differences (“TDs”), and mobile gear is dragged on different LORAN TDs. Even though LORAN is no longer active, the historical agreements appear to be continuing. Apparently, different GPS manufacturers generate legacy LORAN TDs differently, some more accurately than others, and the discrepancies can cause potential conflicts between fixed and mobile gears.

Pictures of hauling equipment, line, and floatation from the offshore lobster boat are on the following pages.



Figure 1.1: 300 fathoms (600 meters) of 5/8" line, coiled in 50-fathom shots, with one Polyform LD-3 float. This is the typical amount and diameter of line used for one of the vertical lines in an offshore trawl in 100 fathoms of water with high surface currents. Often two Polyform LD-3 floats will be used for increased floatation.



Figure 1.2: Two 180-pound steel anchor sleds. The anchor sleds weigh more than the empty line pack spool (about 135 pounds), i.e. the line pack spool weight is comparable to weights of existing gear.

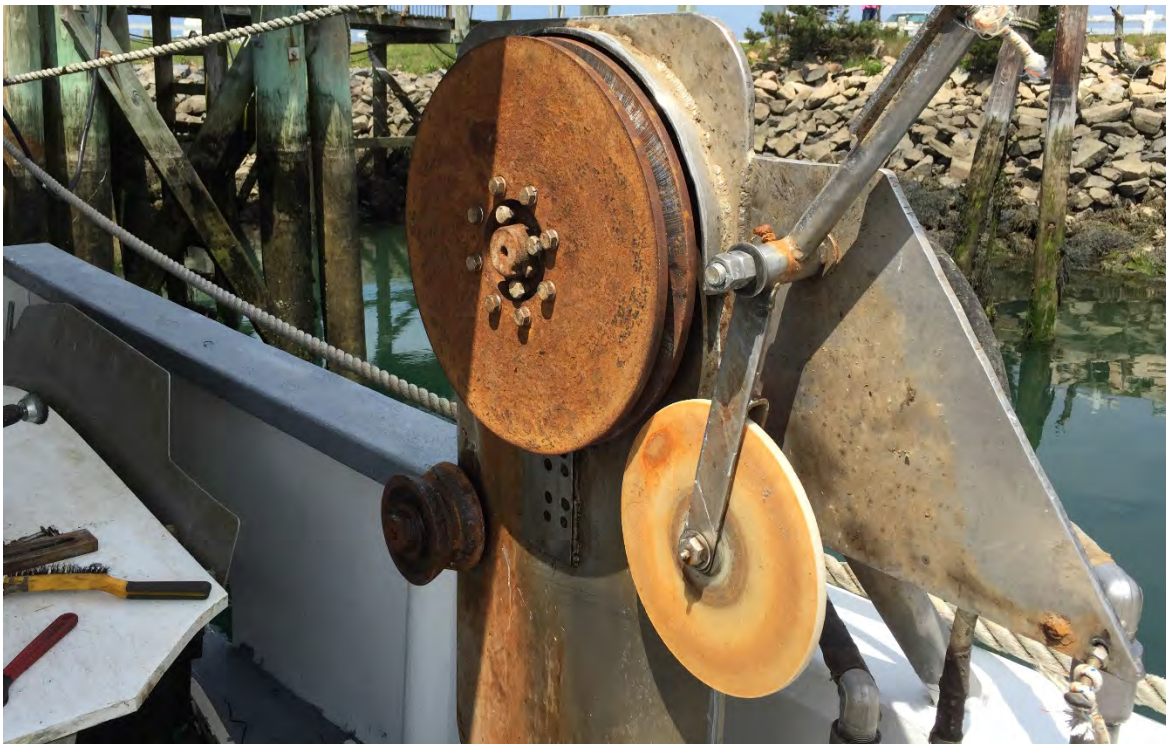

Figure 1.3: Pot Hauler with plates adjusted for 5/8" rope.



Figure 1.4: *Opening in rail through which gear is hauled. The line pack spool is 32" wide and 43" tall.*



Figure 1.5: Rope locker and pot hauler. This rope locker is about 4' x 6' x 6' and can hold the line for three complete trawls of 50 traps each. During hauling, sometimes a crew member is stationed in the rope locker to ensure that the line coming into the locker is coiled neatly.



Figure 1.6: *Pot hauler, pot hauler plates, rope locker, anchor sleds, line.*

Section 1.2: Inshore Boat Fishing 20-Trap Trawls in Massachusetts Bay

Our primary goal for this technology development is the offshore lobster fishery, including potential offshore Gear Development Areas. Inshore areas such as Cape Cod Bay and part of Massachusetts Bay, however, have had seasonal fishery closures due to critical habitat for North Atlantic Right whales, and fishermen in those regions could potentially benefit from availability of rope-less gear. In particular, inshore fishermen with longer trawls would be the ones most likely to consider investing in rope-less gear.

We visited an inshore boat that fishes in Massachusetts Bay east of Stellwagen. The boat is about 38' long and has a captain plus a sternman. They service 800 traps, all set in 20-trap trawls. All of their trips are day trips, often around 12 hours on the water or sometimes more. The set times range from 2 days up to 14 days in the winter. They haul about 15 trawls per day (300 traps per day). It takes about 20 minutes to haul a trawl, typically in 75' (25 meters) of water with 200' (65 meters) of line. They operate up to 300' (100 meters) depth, in which case they generally use 400' of line. When there are higher currents, they will use 300' endlines for 75' water depth. The end lines are 3/8", with 5/16" groundlines. The traps weigh 60-70 pounds each. With their echosounder (Furuno FCV-528L) they can see the vertical line as it goes down with the traps.

The captain was very conscious of avoiding whale entanglements, and uses no knots in his endlines, but rather splices everything. The endlines are orange line with occasional orange flagging to improve potential visibility for right whales. They use swivel breakaways with about a 600-pound breaking strength. The bottom third of the endline is poly floating line.

Section 2: Rope-less Fishing Technology Background and Related Work

Endangered whales and turtles are known to become entangled in vertical lines used in fixed-gear fisheries. Heavier lines, as in the offshore Gulf of Maine lobster fishery, are a particular risk for endangered North Atlantic Right whales (Knowlton et al, 2015). Reducing the number of vertical lines in the water column at any given time is the primary motivation behind developing rope-less fishing technology. A rope-less fishing gear system secures the vertical lines used in fixed fishing on the seafloor until they are released for hauling.

Our main goal with this project was to design a research prototype for rope-less fishing gear for the offshore Gulf of Maine lobster fishery. We fabricated three prototype units that will enable research deployments from operational fishing vessels, to evaluate the potential of rope-less fishing for the Gulf of Maine offshore lobster fishery. At this stage, these units are not being proposed as a commercially viable product, but mainly as a research project to evaluate how such a system might be developed to work within the operational fishing circumstances of the offshore lobster fishery. While design-for-manufacture and larger production numbers will reduce costs, the initial prototype batch of three units cost approximately \$13,000 each.

Although initially designed for the offshore fishery, a key design goal was to make the system modular, so that various components can be scaled from the more oceanographically challenging offshore environment to shallower inshore areas. A system initially designed for the challenging offshore environment will likely scale down to the inshore fishery, whereas starting with the inshore fishery could potentially end up with a design that might not scale successfully to offshore conditions.

Our system was designed for the offshore lobster fishery for several reasons. First, the most promising existing entanglement mitigation approaches for the inshore fishery – namely weak links and weak lines – are not viable for the heavy offshore lobster fishing trawls of up to fifty traps. Second, none of the previously demonstrated rope-less fishing systems have adequate buoyancy to operate in the offshore lobster fishery, where strong surface currents and deep water require flotation on the order of 140-180 pounds simply to bring the rope to the surface. Finally, this research can contribute to potential rope-less fishing Gear Development Areas.

Figure 2.1 shows a standard offshore lobster trawl of traps (McCarron and Tetreault, 2012). The groundlines are sinking ropes, and the entanglement hazard is presumed to be mainly from the vertical lines. The weights, rope lengths, and number of traps per trawl are typical of some offshore areas in the Maine fishery. The offshore fishery along the edge of the Continental Shelf has similar configurations, but generally with heavier gear, longer lines, and more traps per trawl.

Section 2.1: Overview of Rope-less Fishing Technology

There are several key design questions for categorizing rope-less fishing systems and release systems. Each of the categories is explained in further detail below.

- How is the rope secured on the seafloor?
 - Main types consist of a line canister (or mesh bag), and line spool.
- How is the release triggered?
 - Main types are galvanic action, timer, and acoustic commands.
- What is the release mechanism?
 - Main types are corroding “burn” wire, solenoid, and motor.

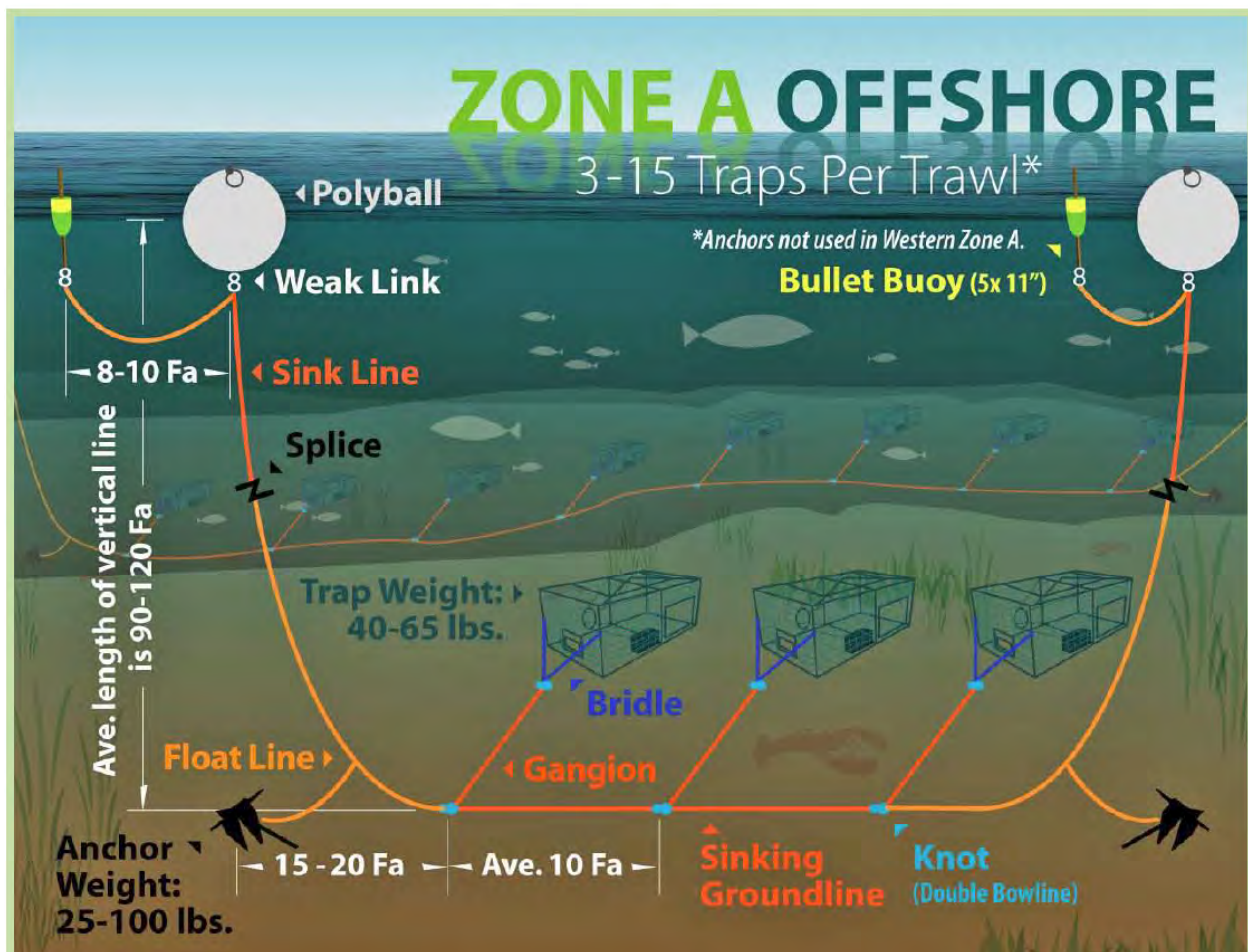

Figure 2.1: A standard configuration for an offshore lobster trawl, shown for a Maine fishery (McCarron and Tetreault, 2012). The offshore fishery along the edge of the Continental Shelf is generally similar, but with heavier gear and more traps per trawl.

Section 2.1.1 Methods of Securing the Rope on the Seafloor

To secure the rope on the seafloor, a “line pack” has been used. The main approaches for designing a line pack are to use a line canister or a line spool. In a line canister, the line is packed into a container, then pulled to the surface with a float. Generally, the line is randomly packed into the canister, and usually uses a torque-free braided rope to avoid kinks. Mesh bags can also be used as line canisters (Liggins and Westley, 2011). Although they are nominally “randomly-packed”, care must be taken when packing a line canister. If the packing is too loose, the rope can be moved inside the canister by water currents, causing tangles and release failures. If the packing is too tight, the float might not pull the rope out of the canister. Figure 2.2 shows two line canister approaches, a commercial system from ORE Offshore and a mesh bag from Liggins and Westley (2011) from the New South Wales Australian lobster fishery, and a line spool developed by FioMarine.

A line spool is what we chose for our prototype design. Line spools are often used for longer lengths of line, on the order of 300 meters or longer. Typically, on each row of wraps around a line spool, a mastic or adhesive secures the wraps in place before the next row of wraps is put onto the spool. Silicone adhesive is often used as the mastic, although alternate materials such as biodegradable cornstarch-based mastics are conceivable. Novel line packs are also currently being developed by EOM Offshore and others where there is no central spool in the line pack, but rather the coiled line is “cast” with an adhesive into the desired form. To reduce a fishing vessel’s time on site for turning around a rope-less fishing trawl, one possibility we considered for our line spool approach is an onshore service industry that provides pre-spooled line spool cartridges to fishing vessels. Line packs that are cast into forms with adhesive might also be an approach to providing line spool cartridges that can quickly be used for re-spooling the line.



Figure 2.2: *Three line pack methods. Left: Line canister (ORE Offshore). Middle: Mesh bag as line canister (Liggins and Westley, 2011). Right: Line Spool (FioBuoy, FioMarine).*

Section 2.1.2 Methods of Triggering the Release

The second main categorization of rope-less fishing systems and releases is how the release is triggered. The simplest and least expensive approach is to use a galvanic timed release, where the corroding metal is sized to provide an approximate release time. The release time is not very accurate, if the surface of the metal becomes fouled with oil or a biofilm. A timer-based approach is what we chose for our prototype system, as a cost-effective method to provide accurate release times without requiring fishing vessels to purchase potentially expensive acoustic release deck gear. A timer-based release can be set such that the line is on the surface ready for hauling when the fishing vessel is expected to be back on site. Finally, adding an acoustically-commanded release in parallel with a timer-based release allows flexible hauling times in the event of changing weather or fishing vessel schedules. Acoustic releases, and in particular the associated acoustic deck gear, can be relatively expensive, primarily because of the very small and specialized market. If they were in a large commercial market, acoustic releases and deck gear could come down in unit costs and be sold on par with or as part of fish-finding sonars or echosounders, ranging from about \$500 for low-end consumer models to around \$5000 for higher-end commercial instruments and transducers.

Section 2.1.3 Types of Release Mechanisms

The final categorization of rope-less fishing systems is the release mechanism itself. Typically there is a lever system to provide the appropriate amount of mechanical advantage so that the actuator's force or torque can be relatively small to release a larger load. The means by which the lever is released can be a corroding burn wire, a solenoid, or a motor. A corroding burn wire is generally assumed to be the least expensive, though it means a consumable release link needs to be replaced each time the system is recovered. The expense of the consumable links could be considerable for commercial fishing operations. For example, Sub Sea Sonics sells release links for \$8 or \$12 each, for loads of 40-90 pounds or up to 200 pounds, respectively. The offshore rope-less system design described in this technical report would require a 150-pound release link (\$12). An offshore fisherman with 30 trawls and a year-round average soak time of five days would consume about 2000 release links per year, costing about \$24,000 per year for the links alone. Burn wires also have potential biofouling concerns, and the tension on the burn wire has to be designed appropriately – well under its rated tensile strength, but enough to ensure that the release triggers reliably – as this is a common failure mode for burn-wire systems.

Many commercial releases use solenoids as the release actuator. In a solenoid, the actuator is moved by applying electrical current, creating a magnetic field. The actuator motion can be linear or rotary; rotary solenoids are often used for release mechanisms. Rotary solenoids usually are internally a linear solenoid with a torsional spring translating a linear motion into a rotary motion. To conserve energy, release mechanisms generally use a latching solenoid, where current only has to be applied to release the device, rather

than traditional solenoids where current would be applied continuously to hold the actuator's position in the non-released state. Most solenoids are single-shot devices, and must be reset manually, without any provision for a second release attempt if the first attempt fails.

The approach that we chose for our prototype system is to use a DC motor with motor encoders. The encoders provide feedback to the microcontroller, which can then reverse motor drive directions and continue to drive the motor back and forth to try to recover from a release failure.

Section 2.1.4 Summary of Top-Level Design Decisions

In all design decisions for this rope-less prototype system, we selected the approach that we believe to be most robust and reliable – a line spool rather than a line canister, a timer with acoustic option rather than galvanic action, and a motor rather than burn wire or solenoid. These more robust options are generally slightly more expensive, but not dramatically so, especially for a prototype research system where the goals are to evaluate a reliable rope-less fishing in the Gulf of Maine lobster fisheries, rather than to drive the manufacturing cost as low as possible.

Section 2.2: Previous Related Work in Rope-less Fishing

Previous related work in rope-less fishing products, demonstrations, and design studies are summarized in Table 2.1. That table also compares previous work with the requirements for the offshore New England lobster fishery. In particular, the buoyancy of previously-demonstrated rope-less fishing systems, with a maximum buoyancy of 38 pounds, is inadequate for deployment with the high currents and deep water of the offshore fishery (180 pounds needed for ½" line with 3:1 scope).

Less buoyancy would be required for smaller line diameters. We set ½" as the minimum line diameter for several reasons. The line diameter for pot haulers is set by adjusting the separation of two steel plates; the line diameter setting is not easily adjusted on the fly. The sinking groundlines in a trawl can be up to 2500' (750m) long, which would comprise roughly half of the overall length of line hauled in 300m of water with a scope between 2:1 and 3:1 (600m-900m of vertical line). Sinking groundlines gather sediment that abrades the rope fiber as it is forced between the hauler plates, and so offshore groundlines are typically 5/8" line to increase the longevity of the rope. The vertical line cannot have a dramatically smaller diameter than that of the groundline, since the pot hauler plates are not easily adjusted. In addition, small diameter ropes such as ¼" pose a potential injury hazard for fishermen that can cause loss of fingers if the line breaks or comes off the pot hauler. Therefore, we have set ½" line as a requirement, in turn requiring higher buoyancy for the line spool flotation.

Summary

We are targeting the offshore lobster fishery because heavier lines appear to pose a higher risk for endangered North Atlantic Right Whales, and because potential inshore mitigation approaches such as weak links and weak lines are less viable for large offshore trawls. We surveyed the previous work on rope-less fishing gear, and none of it provides anywhere near the required buoyancy to bring a line to the surface (38 pounds for the best-documented prior work, versus 140-180 pounds required for the offshore fishery along the edge of the Continental Shelf). For an initial prototype design, our design decisions were based on what we believe will be the most robust approaches to each component of a rope-less fishing system.

Table 2.1: An overview of related work in rope-less fishing products, demonstrations, and studies. The buoyancy required to return a rope to the surface in the high currents of the offshore New England lobster fishery, at about 180 pounds, is several times higher than the buoyancy provided by previous rope-less fishing systems.

<u>Name</u>	<u>Depth</u>	<u>Buoyancy</u>	<u>Line Capacity</u>	<u>Release Type</u>	<u>Line Pack Type</u>
FioBuoy, FioMarine, Australia	Two models, 100 meters and 200 meters	Up to 18 pounds, air-filled plastic spool	Approx. 250m of ½" line	Timer or acoustic	Line spool
DeAlteris 1999; Allen & DeAlteris 2007	200 meters	38 pounds (14" trawl float)	300m of 3/8" line	Acoustic (Benthos)	Random-pack canister
Hopkins & Hoggard 2006	Tested in 20 meters	Not specified	Not specified	Acoustic (Sub Sea Sonics AR50)	Line canister
Liggins & Westley, 2011, New South Wales, Australia	120 meters	Two small trawl floats (estimated <50 pounds)	Not specified	Acoustic with galvanic action backup	Mesh bag line canister
Turner et al 1999 (design study)	1200' (365m)	8 pounds (plastic trawl float)	1400' (425m) of 1/8" rope	Acoustic mock-up with fish-finder sonar	Line spool
Offshore New England lobster fishery (this study)	300 meters (and at Shelf break, need safety margin)	Need 180lb in 2-knot current in 300m depth with 3:1 scope for margin with wind, waves, and surface layer.	Need scope of 2:1 to 3:1, i.e. 600m to 900m line. Need at least ½" line for pot hauler compatibility.	Timed release, or acoustic release	Line spool

Section 3: Buoyancy Modeling and Line Spool Design Decisions

Significant time was spent researching various line packs previously used in ropeless fishing and other release systems. A line pack holds the vertical line on the seafloor until it is released, at which point a float brings the line to the surface for recovery. The two main types of line packs are line spools and line lockers. For an offshore system, we determined that a line spool would be more reliable, and that is what we used for our prototype design. For inshore systems with less rope, however, a line locker might be reliable enough with less complexity and cost. The modularity of our design would allow a future inshore version to use a line locker approach.

In a line locker, the line is coiled in a canister or mesh bag that sits on or near the ocean bottom. Upon release, the line is pulled from the canister via a flotation device. For relatively short lengths of line, freely-packed line canisters can work well with appropriately chosen rope, such as torque-free braided ropes. For the long lengths of line (600-900 meters) and the relatively large minimum rope diameter (1/2") required for the offshore lobster fishery, however, a freely-packed line canister would become increasingly large, increasing the danger of tangling and release failures. Line canisters cannot be packed too loosely, because the rope can move and tangle inside the canister due to water motion. Line canisters also cannot be packed too tightly, because the line might not successfully pull out of the canister. Additionally, since the line locker would remain relatively close to the trawl anchors, the canister could potentially increase the difficulty of retrieving the trawl anchors on board the fishing vessel. One of the largest cautions from experts in these technologies was the care required in coiling the line in the locker. Any sort of improper twist in the line, knots, or slack in the packing could create potential tangles in the line, preventing the float from reaching the surface. This risk of failure in using the line locker approach was too great and was abandoned.

Experts in these devices have been utilizing various incarnations of line spools over the course of thousands of deployments with excellent success. Several well-known practices and procedures are in place for winding line packs for reliability. Based on the expertise available at WHOI, it was determined that pursuing a line spool arrangement was the lowest-risk solution. In terms of handling, the flotation and the empty line spool come to the surface first, are recovered by the fishing vessel, and then the fishermen haul the trawl as normal. Getting the flotation spool on board and out of the way earlier in the process also provides time while the trawl is being recovered to reset the spool and prepare it for redeployment.

Our visit with Massachusetts offshore lobster fishermen revealed some critical information beyond that the information provided by the report "Lobster Pot Gear Configurations in the Gulf of Maine" (McCarron and Tetreault, 2012). The offshore fishermen reported they were working on the 100-160 fathom (180-300m) bathymetry contour lines at the edge of the continental shelf near various canyons. The water depths in the areas surrounding the deeper contour change drastically over short distances, reaching

up to 200-400 fathoms (365-731m) over a distance of less than one nautical mile (see Georges Bank and Vicinity Bathymetric Chart). Additionally, they were often deploying their gear where eddies from the Gulfstream would induce strong currents of 1-2 knots that would submerge a pair of Polyform floats that were providing ~180lbs of buoyancy. To compensate for the drastic changes in bottom topography and strong current, they use a scope of vertical line equal to three times that of the water depth. Additionally the fishermen were using a 5/8" diameter line rather than the 1/2" line in order to increase the longevity of the line. The sinking ground line in particular picks up sediment grains that then abrade as it is squeezed through the pot hauler plates. Similarly, salt crystals in line that has dried out without a fresh water rinse can abrade rope fibers. Using larger diameter line increases the useful life of the line.

During the visit with the fishermen the following design parameters were generated for the system:

1. The flotation depth rating needs a safety margin greater than original 300-meter depth specification due to the drastically changing bottom contour. Having the flotation fail at depth would result in lost gear.
2. The system needs to be sized (physical dimension and weight) for easy handling where minimal hauling gear is available (no A-frames or cranes). The fishing vessels did not have the full suite of lifting equipment that is often available on oceanographic research vessels. As such the device needs to be sized comparably to existing fishing gear for fishermen to lift and maneuver the device with limited mechanical assistance.
3. The spool would need to hold sufficient line such that the available buoyancy can overcome the water currents at the continental shelf. The offshore fishermen reported using 200%-300% scope as opposed to the 150% scope reported by McCarron and Tetreault (2012).
4. The spool system should minimize the time required at sea for redeployment. At present a crewman is often dedicated to figure-eight the line coming aboard from the trawl down in the line locker of the fishing vessel. This same man could possibly be trained to properly spool line onto a line pack but it would take significantly more time while on site. In a system based on an acoustic release, the acoustic transducer should be prowed above the flotation to provide a clear line of sight to the surface. Flotation acts as an acoustic baffle that prevents sound from passing through the material due to the acoustic impedance differences.
5. The system should be rugged enough to handle the rigorous handling of gear that is typical on board fishing and oceanographic research vessels, and with minimal mechanical assistance. There is not ample room on the deck of an offshore fishing vessel, and typically gear gets dropped and dragged around on the deck.

Initial design concepts used 14” trawl floats attached on top of a line pack spool similar to existing line pack arrangements. Trawl floats are inexpensive and readily available. However, the amount of flotation required for the operational area of interest due to the depth and water currents would have required multiple trawl floats, making the overall size of the system unwieldy, whether as a single component or as two separate components as in a typical mooring arrangement.

Among the existing designs that are in use at WHOI, the line spool approach seemed the most promising. A line spool designed at WHOI that incorporates flotation into the spool itself is shown in Figure 3.1.

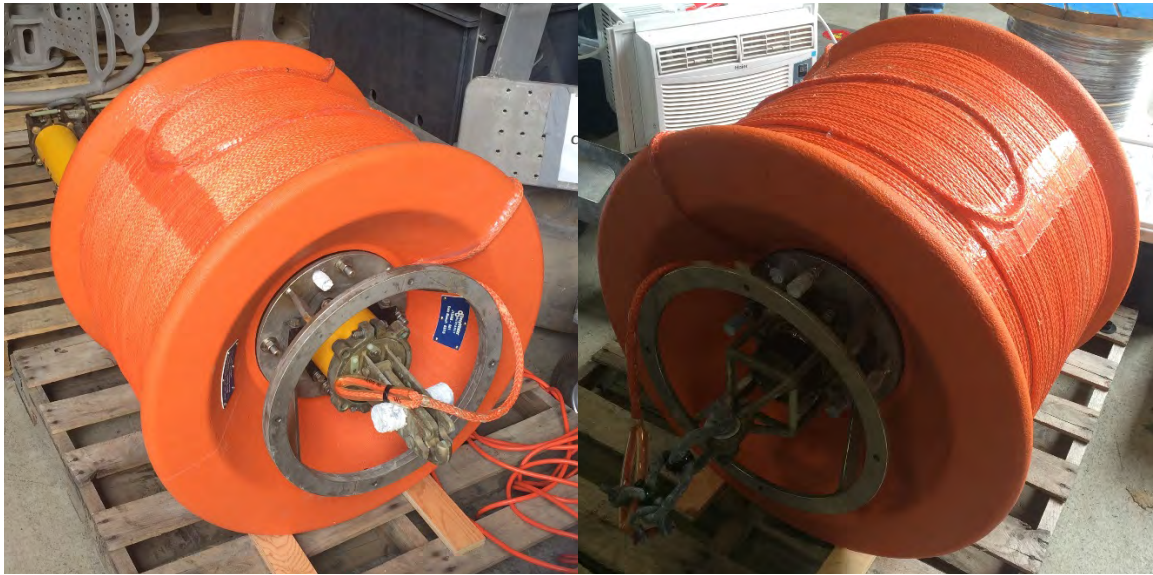

Figure 3.1: Existing WHOI-designed flotation spool using syntactic foam and a commercially available release.

Having the spool include the flotation makes the design more compact while allowing for a significant volume of otherwise unused space for flotation material. Installing the acoustic release in the center of the flotation spool allows the acoustic transducer to have an unblocked signal path to the ocean surface. Traditional moorings have the acoustic release underneath the flotation spheres and are therefore subject to an acoustic dead zone, through which acoustic signals cannot propagate. The dead zone causes a loss of communication with the release in certain orientations, reducing reliability. The downsides of the existing WHOI line spool were the size, weight and the cost. Traditional syntactic foam is very heavy to achieve a given buoyancy. Flotation buoyancy of 190 pounds has an air weight of about 200 pounds for the foam alone. The use of commercially available acoustic releases drives the costs beyond what is likely supportable in the fishing industry.

To determine the amount of flotation required for this application, the modeling package WHOI Cable (Gobat and Grosenbaugh, 2000) was utilized to simulate a simple buoy, catenary cable, and anchor system. Water current information for the operational

area in question was extracted from the University of Massachusetts Dartmouth Gulf of Maine and Georges Bank tidal simulation database (http://fvcom.smast.umassd.edu/research_projects/GB/tidal_simulation.html).

The WHOI Cable simulations utilized a simple cylindrical buoy, neutrally buoyant line, and an anchor. Variables such as water currents, wind speed, wave conditions, line length, and line diameter were modified between simulations to determine the primary drivers for the flotation requirements. When a buoy is fully submerged, the tension in the vertical line will be equal to the total buoyancy of the buoy. By selecting a buoy size that is larger than required, it is possible to look at the tension in the line relative to various parameters to obtain an understanding of the forces involved.

Table 3.1: Comparison of vertical line tension for various water currents.

Vertical Line Diameter (inches)	Vertical Line Length (m)	Water Currents (m/s – Surface, Bottom)	Wind Speed (m/s)	Waves Amplitude (m), Period (s)	Max Line Tension (N)	Max Line Tension (lbs)
0.5	600	0.2 – 0.1	5	0.5, 7	80	18
0.5	600	0.4 – 0.1	5	0.5, 7	150	34
0.5	600	0.6 – 0.15	5	0.5, 7	310	70
0.5	600	0.8 – 0.15	5	0.5, 7	500	112
0.5	600	1.0 – 0.2	5	0.5, 7	770	173

At the edge of the Gulf Stream, surface water currents can be as high as 2 knots (1m/s). In the comparison of vertical line tension versus water currents for a fixed length of line, a significant increase in line tension results from an increase in water currents. The last result in Table 3.1 closely matches what was reported to us by offshore lobster fishermen. Offshore fishermen have observed two Polyform LD-3 floats (with 180 pounds of buoyancy) becoming submerged in currents in the range of 2 knots. Here we can see that the tension in the line is approximately 173 pounds. Accounting for other simulation variables shown below, it is easy to imagine the situations local fishermen were experiencing.

Table 3.2: Comparison of vertical line tensions for various vertical line lengths.

Vertical Line Diameter (inches)	Vertical Line Length (m)	Water Currents (m/s – Surface, Bottom)	Wind Speed (m/s)	Waves Amplitude (m), Period (s)	Max Line Tension (N)	Max Line Tension (lbs)
0.5	450	1.0 – 0.2	5	0.5, 7	875	196
0.5	600	1.0 – 0.2	5	0.5, 7	770	173
0.5	750	1.0 – 0.2	5	0.5, 7	650	146
0.5	900	1.0 – 0.2	5	0.5, 7	580	130
0.5	1050	1.0 – 0.2	5	0.5, 7	500	112

Local offshore fishermen report using 600m-900m of line in waters of 300m depth to try to prevent their surface floats from becoming submerged. In the comparison of vertical line tension for various line lengths, shown in Table 3.2, it can be seen that line tension decreases significantly as the line length is increased. In 300m of water with 1 m/s of surface current and 750m-900m of line length the tension decreases below the 180 pounds of buoyancy that the Polyform floats provide, allowing the floats to remain on the ocean surface as confirmed by the fishermen.

Table 3.3: Comparison of vertical line tensions for various wind speeds.

Vertical Line Diameter (inches)	Vertical Line Length (m)	Water Currents (m/s – Surface, Bottom)	Wind Speed (m/s)	Waves Amplitude (m), Period (s)	Max Line Tension (N)	Max Line Tension (lbs)
0.5	600	1.0 – 0.2	5	0.5, 7	770	173
0.5	600	1.0 – 0.2	10	0.5, 7	~770	~173
0.5	600	1.0 – 0.2	15	0.5, 7	~770	~173

In the comparison of vertical line tension for various wind speeds, shown in Table 3.3, WHOI Cable does not show a significant change in line tension as the wind speed is increased. The water currents appear to be the main driver in the simulation.

Table 3.4: Comparison of vertical line tensions for various wave conditions.

Vertical Line Diameter (inches)	Vertical Line Length (m)	Water Currents (m/s – Surface, Bottom)	Wind Speed (m/s)	Waves Amplitude (m), Period (s)	Max Line Tension (N)	Max Line Tension (lbs)
0.75	600	1.0 – 0.2	5	0.5, 7	880	197
0.75	600	1.0 – 0.2	5	1.0, 7	930	209
0.75	600	1.0 – 0.2	5	1.5, 7	950	213
0.75	600	1.0 – 0.2	5	2.0, 7	1000	224

Two results can be seen in the comparison of vertical line tension for various wave conditions, shown in Table 3.4. Here the line diameter has been increased. Comparison to previous results shows an increase in vertical line tension as the diameter increases due to the added hydrodynamic drag. Additionally we can see that as the wave amplitude is increased a small increase in vertical line tension is generated.

The empirical information provided by local offshore fishermen regarding how much buoyancy they used provided a reference against which to compare the WHOI Cable simulations. From the simulations it was possible to nearly replicate the situations which the fishermen were experiencing with their existing fishing gear, for example that generally they used 180 pounds of floatation to bring the line to the surface, but that sometimes with strong currents, even 180 pounds of floatation was pulled underwater by the tension on the rope. The simulation results also provide some reasonable bounds on the operational parameters in order to design the flotation spool.

A modular design approach was chosen for the rope-less fishing system as shown in Figure 3.2. A flotation core is sandwiched between two spool cheek cages. Both cheek cages provide a smooth surface to secure the line pack and provide an interrupted pay-out path for the line. The cheek cages also provide a means to handle the full assembly as well as protect the release mechanism and acoustic transducer. The cages were designed such that the flotation spool assembly could sit flat on the deck, to ease handling relative to an assembly that cannot sit flat and must be held at all times. The release mechanism and electronics are installed in the center of the flotation core with the transducer remoted to the top of the flotation spool, such that it has a clear acoustic line of sight to the ocean surface.

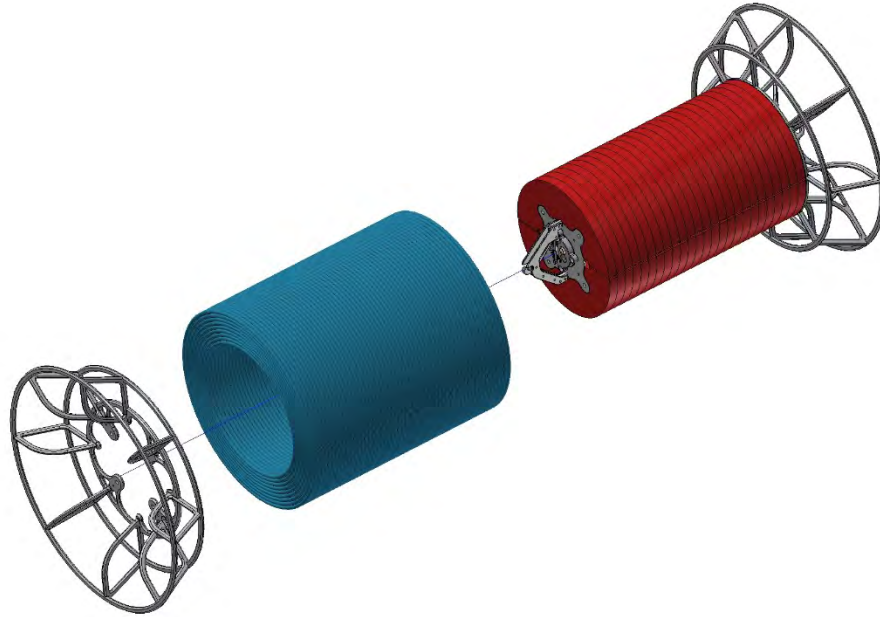

Figure 3.2: *Modular Line Pack Spool*

An internal spine assembly secures the release mechanism and flotation to the top spool cheek cage even when the bottom spool cheek cage is removed. The bottom spool cheek cage can be quickly removed via four bolts and a pre-wound line pack cartridge can be loaded onto the spool. Once the new line pack cartridge is loaded onto the flotation core, the bottom spool cheek plate can be reinstalled, securing the line pack onto the spool.

Although spooling the recovered line onto the flotation spool via traditional means (by spinning the spool and winding the line) is possible, it would be burdensome and time consuming to handle these tasks while on site, adding precious time and labor to each trawl recovery. Utilizing a prewound line pack spool allows for a quick turn-around on site. Cartridges could be wound by fishermen while on shore or via a service industry that could be created to collect recovered lines from fishermen as they return to port and then replaced with custom length line pack cartridges.

The flotation spool prototypes that were generated (Figure 3.3 and Figure 3.4) during the period of performance were designed to accommodate a line pack cartridge containing approximately 900m (or less) of ½" diameter neutrally-buoyant line. The overall system dimensions are approximately 32" diameter by approximately 43" tall. The flotation spool assembly weighs approximately 130 pounds in air unloaded and as much as 340 pounds in air when fully loaded with 900m of ½" line. The available buoyancy of the system as built is 145 pounds. Positively buoyant line could be used as added buoyancy at the cost of requiring a heavier anchor. Larger diameter lines could also be utilized at the cost reducing the total line length that the spool can support.

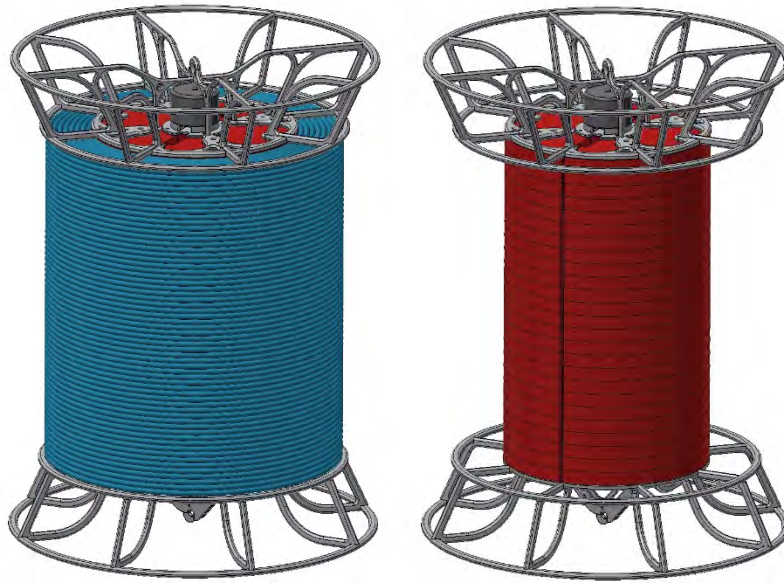

Figure 3.3: Fully assembled modular flotation spools. Left: Loaded with 900m 1/2" line; Right: Unloaded.

To keep the system's overall weight down and the available buoyancy up, the flotation core is constructed from sheets of Divinycell HCP-70 foam. HCP-70 is a low density foam that has an operational depth rating of 450m and a crush depth rating of 700m. Utilizing a low density foam also keeps the overall size of the system smaller than would otherwise be possible. Lower density foams are available, but at the cost of reduced operating depth.



Figure 3.4: Modular Flotation Spool Prototypes

Air filled flotation mechanisms were investigated but ultimately proved to be a source of risk in terms of fabrication costs and reliability. Some other similar systems like

the FioBuoy (FioMarine, Australia) use a plastic air-filled housing as the primary flotation mechanism, but are limited in the operational depth that can be achieved in terms of physical strength and line capacity, require a completely different assembly, and have limited buoyancy of approximately 18 pounds for the 200-meter model.

The modular nature of our design allows for scalability to accommodate a variety of different environmental parameters without having to modify the entire design. For example if a lighter weight system were required to operate in shallower waters, the foam core could simple be swapped out for a lower density foam to reduce the overall weight while increasing the available buoyancy.

Based on the simulation results and the empirical observations from local offshore fishermen the prototype systems that were designed and built should be able to operate in 300m water depth utilizing 900m of line in currents of up to 2 knots (1m/s). The system size and weight should be manageable based on existing equipment that the offshore fishermen are currently handling. The costs of the prototype systems is relatively high at about \$13,000 per timer-based unit, but the cost can be addressed with volume manufacturing processes, including potentially manufacturing molded foam units.

Section 4: Release Mechanism Design Decisions and Description

Commercially available acoustic releases are can be quite expensive with prices ranging from \$6,500 to \$15,000, not including ~\$15,000 in required topside deck gear. The rope-less fishing system needs to be a lower cost device (< \$10,000) to aid in adoption rates. As such it was decided to leverage our existing expertise in acoustic modem technology and electromechanical systems to develop a lower cost release system (Freitag et al 2005; Gallimore et al 2010).

There are several techniques available for retrieving heavy loads suspended below the ocean surface. All require a system that provides some form of mechanical advantage and a release component. The release component can come in a variety of styles, and these were investigated for use in the rope-less fishing system. We consulted with the most experienced WHOI engineers and mooring operations personnel to discuss the pros and cons of various release types. Collectively, these engineers and operational technicians have designed and fabricated more than a dozen different models of releases, produced hundreds of units, and made thousands of deployments.

Burn wires use an electrical current passing through a wire exposed to seawater that causes it to corrode. The burn wire is often used to secure the end of a lever. Once the wire corrodes away the lever is allowed to move freely and release the load hanging from its other end. Burn wires are elegant because they are inexpensive to replace but they do require that stock is kept on hand. Burn wires sometimes fail to corrode as intended and are considered a one-shot device (use it once then replace). Ultimately, burn wires were considered a reliability risk for this project.

Rotary and linear solenoids are used quite frequently in commercially available acoustic releases. The solenoid usually restrains one end of a lever with a spring-loaded locking mechanism while the other end of a lever secures the load. An electrical current is supplied to the solenoid causing the solenoid shaft to unlock the mechanism. To overcome potential biofouling or corrosion that may have accumulated on the release lever or restraint catch, a powerful spring is often incorporated into the mechanism inside the housing to ensure that the restraint catch successfully frees the lever arm. Once the end of the lever is free to move, the load is released. Rotary and linear solenoids are used commonly in the industry with high reliability. However, the size and one-shot nature of the devices were considered undesirable for this application. Increased mechanism sizes require larger housing, and one of our goals was to keep the system size to a minimum. In the event of a release mechanism getting fouled and not releasing on the first attempt, a one-shot device does not allow for a remote reset. A manual tool is often required to reset the device.

Ultimately, it was decided to utilize a small DC gearhead motor with an attached rotary encoder. The motor is attached to a shaft that secures one end of a lever system while the other end of the lever secures the load. Once the motor is energized, a shaft rotates a key that prevents movement of the lever system. Once the key is no longer an obstruction, the lever system is free to move and the load is released. By monitoring the encoder signals as the motor is energized, it can be determined if the motor is moving as commanded. The motor state can be reported back to the user even when the system is remote (if properly equipped, for example with acoustic communications). The motor can also be commanded to rotate multiple times or in opposing directions in the event that the key is obstructed in one orientation but not the other. Although the costs for the motors are often higher than other release types, the feedback and proven reliability justify the added costs.

The release mechanism and assembly (Figure 4.1) was also designed as a modular component. The housing is one of the WHOI Acoustic Communication Group's standard aluminum Draw-Tight designs, and is rated to 1000m. The housing accommodates timer-based or acoustic modem-based release hardware, a rechargeable Lithium-Ion rechargeable battery pack, battery charger with power distribution and the release motor. On the endcap, connectors for a remote acoustic transducer and physical console connection to the controller are available, as well as a rotary power switch and status viewport. The viewport allows the user to see LED indicators without opening the housing.



Figure 4.1: *Modular Release System*

Many commercially available systems use the pressure housing of the release as a strength member, with the full mechanical load of the system applied directly on the pressure housing. This adds cost and complexity to the housing design. In our design, the housing is mounted to the lower spine plate of the flotation spool assembly such that the loads are transferred to the spine rather than to the housing. This allows for a smaller electronics housing and for modular release components.

Figure 4.2 shows the external release components. The external release components consist of the lower spine plate, two release cheek plates (turquoise), two lever arms (red and yellow), and a motor shaft release latch (green). The load is attached in the hook of the lower lever arm (red) forcing it to rotate clockwise about its pivot. The top of the lower lever arm (red) makes contact with the upper lever arm (yellow) forcing it to rotate counter clockwise about its pivot. The end of the upper lever arm (yellow) makes contact with the release latch attached to the DC motor shaft. When the motor shaft rotates the latch (green) the upper lever arm is free to rotate, allowing the lower lever arm to rotate to release the load. As built, the mechanical advantage of the release mechanism is approximately 300:1, requiring only a small amount of torque from the DC motor to rotate the key. Requiring less torque requires less battery capacity and smaller electronic components sizes, and allows for a reduced packaging footprint.

The external release components are simple shapes that can be cut on a water-jet or comparable machine to keep component costs down. By making the design modular the assembly could easily be used in other designs, such as on the end of a cage where the cage takes the load rather than the housing as it does in a traditional mooring design. The scalability of the designs allows for flexibility in packaging size and mechanical advantage needs.

A gear handling requirement for a rope-less fishing system is that it not roll around on the deck, so the cylindrical ends of the line spool need to be able to sit flat on the deck of the fishing vessel. Most existing release systems have a relatively large lever arm profile, extending significantly beyond the pressure housing endcap. Using an existing release mechanism with the requirement of sitting flat on the deck would have required a larger line spool cage, in turn increasing gear handling difficulty for the fishermen. To maintain as compact a system as possible, the external release components were designed to have a lower profile than existing releases.

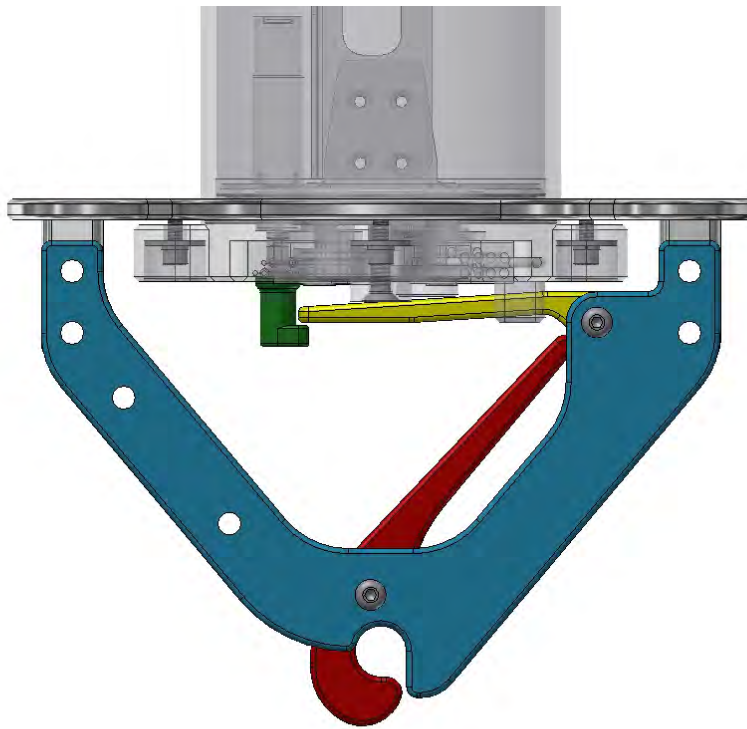

Figure 4.2: *Modular Release Mechanism*

In field deployments, it is recommended that the release be floated at a nominal height of 5m above the anchor and the ocean bottom, in order to avoid fouling with bottom and other residual gear that may be present. This 5-meter length of line between the anchor and the release will also be of use during deployment, as it will allow the spool

assembly to be secured to the deck with temporary quick-release gear-handling lines (or similar) while the trawl is streaming out behind the fishing vessel. When the vessel is at the target deployment location for the line spool (the “rope-less” endline), the quick-release lines on the flotation spool are released and the weight and drag of the trawl will pull the spool off the back of the vessel with minimal handling being required by the crew.

Additionally, having the flotation spools set 5 meters above the bottom may also increase passive acoustic visibility, to aid with gear conflicts if active acoustics are not utilized.

Section 5: Release Electronics Design Decisions and User Interface

The main electronics design goal for this project was to produce a robust timer-based release driver capable of actuating the release mechanism at a specified release time. The release time needs to be configurable via a user interface. While a timer-based release provides a cost-effective method means to release the line spool, it lacks the flexibility of an acoustically-commanded release to react to changes in weather or fishing schedules. Therefore, a secondary design goal was to consider future acoustic release capability, and, where feasible, include the electronics support necessary to enable that capability in a future software and hardware revision. Additional aspects of the electronics design include battery selection and battery controller, as well as provisions for an acoustic power amplifier and transducer in future revisions.

The electronics consist of several circuit boards, namely a microcontroller circuit board, a release driver board, a battery charging board, and a distribution board. In addition, the housing and circuit board stack can immediately accept an acoustic modem and acoustic modem power amplifier in order to implement an acoustic release option in parallel, and in addition to the timer-based option that would remain active.

The microcontroller circuit board is pictured in Figure 5.1. The microcontroller implements the user interface over an RS-232 serial port, sets the release time in a micro-power battery-backed real-time clock, switches the power supply to a low-power “hibernate” state when not releasing or interacting with the user, controls the release motor and monitors its encoders, and includes the analog signal conditioning circuits for a future acoustic low-power detector to detect acoustic release commands.

The release driver board is a separate circuit board that is quite simple and only includes a switchable power supply and a motor driver chip. The release driver board is a separate board for two reasons: first, to reduce risk for the prototype build, and second, to incorporate modularity. If a future version of the prototype uses a different motor or a different actuator (such as a solenoid or a galvanic burn wire), the only circuit board revisions required would be to revise the relatively simple release driver board, rather than having to revise the microcontroller circuit board hardware. The release driver board is shown in Figure 5.2.

The prototype design also includes several features to help evaluate and debug the release and line spool unspooling performance. For example, an orientation motion-sensor chip is integrated in order to record the motion of the release prototype’s line spool through the water column, to help diagnose prototype release failures. In addition, during operational use, the motion sensor will enable the microcontroller to determine whether or not the line spool has successfully released from its anchor, and hence whether or not to continue trying to actuate the release. For the prototype, a micro-SD memory card slot is included to record sensor measurements for diagnostic analysis. The power supply is protected against over-voltage, under-voltage, and reverse-voltage, and against incorrect battery connections. The battery is rechargeable so that the user does not have to open the pressure housing, which could potentially compromise the O-ring seals.

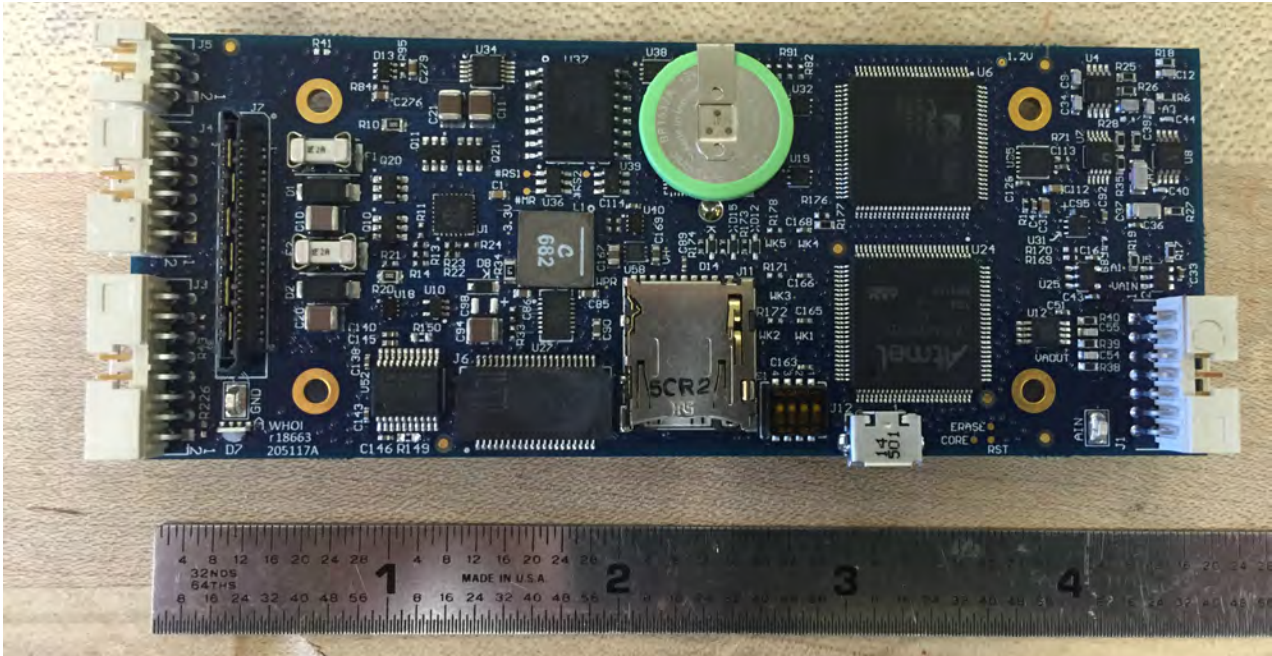

Figure 5.1: The microcontroller circuit board that implements the user interface, the timer functionality, motor control, and acoustic signal detection for a future acoustic release option.

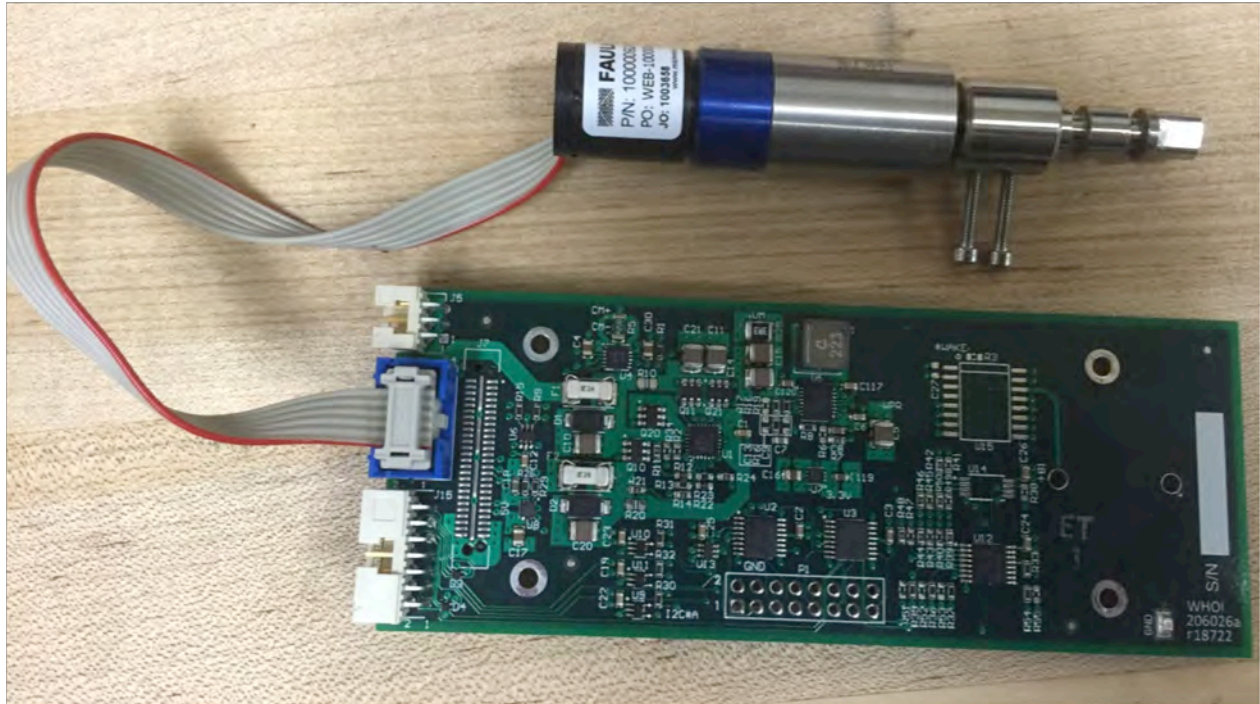

Figure 5.2: Release Driver circuit board and release motor with integrated motor encoders. The release driver board is simple and can be revised easily if used with a different motor or an alternate release actuator, such as a solenoid or a burn wire.

Section 5.1: User Interface

The user interface is implemented over an RS-232 serial port, with parameters 19200 bits per second, 8 bit words, no parity, and 1 stop bit (“19200, 8N1”). The first time the system is used, the clock needs to be set. In subsequent deployments, the user needs to re-arm the release and set the desired release time, then put the system in its low-power state until its release time. Future software revisions can allow more complex behaviors, as well as allowing control over a WiFi or similar wireless link from commodity smart phones or computers, that would reduce the cost of required deck gear.

The user interface menu commands are listed below:

- s** Status: Print current time, unit’s acoustic command ID number, release time, armed/not armed status, and remaining battery voltage.
- t** Time: Set current time.
- i** ID: set unit’s acoustic command ID number.
- c** Correction: Set motor encoder count correction to avoid release motor overshoot.
- r** Release Time: Set desired release time.
- a** Arm release.

- h** Hibernate now: go into low-power state to wait for release time or user interaction.
- n** release Now: for resetting mechanical release state.
- v** Version: display firmware version and hardware version numbers.
- ?** help: display help menu.

The microcontroller we selected, an ARM M4-based Atmel SAM4S, includes hardware cryptographic support that would enable eventual cryptographic signatures that only authorized fishing vessels could release. Any fishing vessel could query a rope-less system on the seafloor, which would then reply with an acknowledgment signal to alert the vessel that rope-less gear is set in that location. The reply signal would need to be very short (hence a small amount of battery energy) so that repeated gear-conflict queries would not significantly deplete its battery. If the reply to gear-conflict queries consumed significant energy, a malicious fishing vessel could repeatedly query rope-less gear to deplete its battery. Since the gear is designed to release when its battery is below a certain level to avoid permanent loss of gear, a malicious fishing vessel could potentially force gear to release by depleting its battery. By minimizing the energy consumed by the reply to a gear-conflict query, the goal would be to make a repeated-query gear theft attack to become extremely time consuming and more trouble than it is worth.

Section 5.2: Battery and Battery Controller

We selected a 14.4V rechargeable Lithium-Ion battery pack from Inspired Energy. We believe that a rechargeable battery is important to minimize the number of times that the electronics housing needs to be opened. Every time the housing is opened, its O-rings and sealing surfaces need to be handled carefully to prevent nicks, dirt, or inadequate O-ring lubrication from causing leaks. With a rechargeable battery, there is no need for the end user to open the housing.

The energy capacity of the battery (20.4 Amp-Hours at 14.4V nominal) is more than adequate for a timer-based release. The battery was sized to provide approximately six months of battery life for a system with an acoustic release, where a low-power acoustic detector is running constantly, as well as occasionally transmitting short acoustic replies for gear conflict “ping” queries from other fishing vessels, or acoustic release commands from the gear’s owner.

Section 6: Evaluation of Passive Acoustics to Detect Gear at Depth

Fixed fishing gear such as lobster pot trawls can have conflicts either with mobile fishing gear dragged over it, or with other lobster gear set on top of it. Fishing gear buoys provide visual cues for other fishing vessels that fishing gear is below. Rope-less fishing

gear would not have a visual cue on the surface, which could increase the likelihood of gear conflicts. In addition to surface buoys, other existing methods help reduce gear conflicts such as setting trawls in consistent orientations (e.g. north-south), or shared fishing ground understandings (e.g. fixed gear set on particular agreed-upon Loran time-differences, and mobile gear dragged on different Loran time-differences, as is currently done along the edge of the Continental Shelf in the offshore Gulf of Maine lobster fishery, using GPS units to display legacy Loran locations).

Acoustic methods could also provide ways to allow fishing vessels to detect the presence of rope-less fishing gear. An acoustic transmitter could be integrated into rope-less gear, and send replies to acoustic queries sent from fishing vessels. This would likely require an additional acoustic transducer and electronic instrument for fishing vessels. Although almost all fishing vessels include an echosounder with a visual display, there is no straightforward way for a rope-less fishing system on the seafloor to reply to echosounder pings and display useful information with existing units.

For this project, we made a preliminary evaluation of passive acoustic detectability of rope-less fishing gear and traps that would not require an acoustic transmitter on the rope-less system at the seafloor. Even if a rope-less system did include an acoustic transmitter, replying to echosounder pings or acoustic interrogations would consume some of the limited battery energy on the release system, and so a system equipped with active acoustics would benefit from passive acoustic detectability.

For the evaluation of passive acoustic detectability, we used a fish-finding depth sounder at the WHOI dock to record returns from both a prototype line spool as well as traps outfitted with various acoustic reflectors. The gear was deployed into the instrument testing well at the WHOI dock (Figure 6.1).

Boats cannot go into the well at the WHOI dock, so the depth sounder that we used was a Vexilar SP200A T-BOX SonarPhone (<http://www.sonarphone.mobi>), which has a dual-frequency 83kHz/200kHz transducer with a 20°/40° beamwidth. The display is shown on a smart phone, from which we made the image captures. We used a gain of 41% for all the measurements, and set the depth range to 0-60 feet rather than auto-ranging.

We performed six experimental treatments, with the group of six experimental treatments preceded and followed by control recordings where no gear and no ropes were in the water. The experimental reflectors are shown in Figure 6.2. The experiments recorded echosounder plots of the line spool, a bare lobster trap, and various acoustic reflectors zip-tied to the lobster trap: PVC pipe reflectors, metal tube reflectors, a steel plate, and trawl floats.

For offshore deployments, the line between the anchor and the line spool would be about 5 meters rather than the approximately 1.5 meters of line used here. The lobster trap was 22" x 48" x 14", and was previous used in Cape Cod Bay. Offshore traps would be somewhat larger. There were six PVC pipe reflectors, each ¾" x 12", with the endcaps

cemented in place. Schedule 80 PVC pipe with $\frac{3}{4}$ " diameter has a rated working pressure of 690psi, which provides roughly a 50% safety margin at the target depths of 300 meters. The metal tube reflectors used were in a bundle of seven 1.5" x 24" pipes with the ends welded shut. The steel plate was $\frac{1}{2}$ " thick, and approximately 7" x 20". There were two trawl floats, each with a 7" diameter.

In terms of operational deployment, traps are stacked on top of each other when on the fishing vessel, and two trap reflector designs in particular seem potentially well-suited to allow stacking. Capped PVC pipes could be zip-tied on the inside of the traps, or a flat reflective plate could be attached on top of them. In order to significantly increase the strength of the return signal from a flat plate, syntactic foam or perhaps metal could be cast with a retro-reflector surface similar to a bicycle reflector, which incorporates many retro-reflectors into a flat surface. Each retro-reflector section would look like the hollow corner inside of a cube, as in a sailboat's passive radar reflector. For a deep-water (~300m) echosounder frequency of about 50kHz (wavelength about 3cm), the retro-reflector facets would likely be on the order of 5-10cm across, which would make an extended structure relatively thick. Alternatively, a few larger retro-reflector hollow cube corners could be placed inside the trap facing up. If capped PVC pipes provide adequate return strength, they would be a very inexpensive option and easy to attach to traps.



Figure 6.1 Left: The well at the WHOI dock where the experiments were performed. It is approximately 45-50 feet deep, with a crane and an opening that is 18 feet wide. Right: The Vexilar SonarPhone used for the sonar imaging, showing the "towfish" weight that was used to depress the sonar transducer and tow it back and forth across the well.



Figure 6.2: *Different experimental treatments measured. From left to right, top: Line pack spool and anchor; bare lobster trap (22" x 48" x 14", previously fished in Cape Cod Bay); lobster trap with six $\frac{3}{4}$ " x 12" PVC pipe reflectors. Bottom: lobster trap with seven grouped 1.5" x 24" metal tube reflectors; lobster trap with 7" x 20" x $\frac{1}{2}$ " steel plate; lobster trap with two 7" trawl floats.*

The recorded echosounder images are shown and discussed below. The sonar transducer was pulled manually on a towfish at a slow walking pace, back and forth across the well opening. The images were recorded when the towfish was at the southern end of a north-to-south transit. The left-most side of most images show the end of the south-to-north transit. The towfish depth was approximately 6 feet below the water surface, and was maintained at an approximately constant depth by keeping a knot in the line level with the steel beam that defines the western edge of the well opening. The nominal depth in the well is about 45-50 feet. For the control recordings, no gear or line was in the water except for the towfish and transducer. For all other experimental recordings, the rope from the crane, as well as its hook and shackle, were in the water as well as the experimental gear. Schools of baitfish (3"-6" in length) were visible on and off throughout the experiment. Forklifts, generators, trucks, other cranes, motorboats and ferries were active on the dock and in nearby waters throughout the experiment.

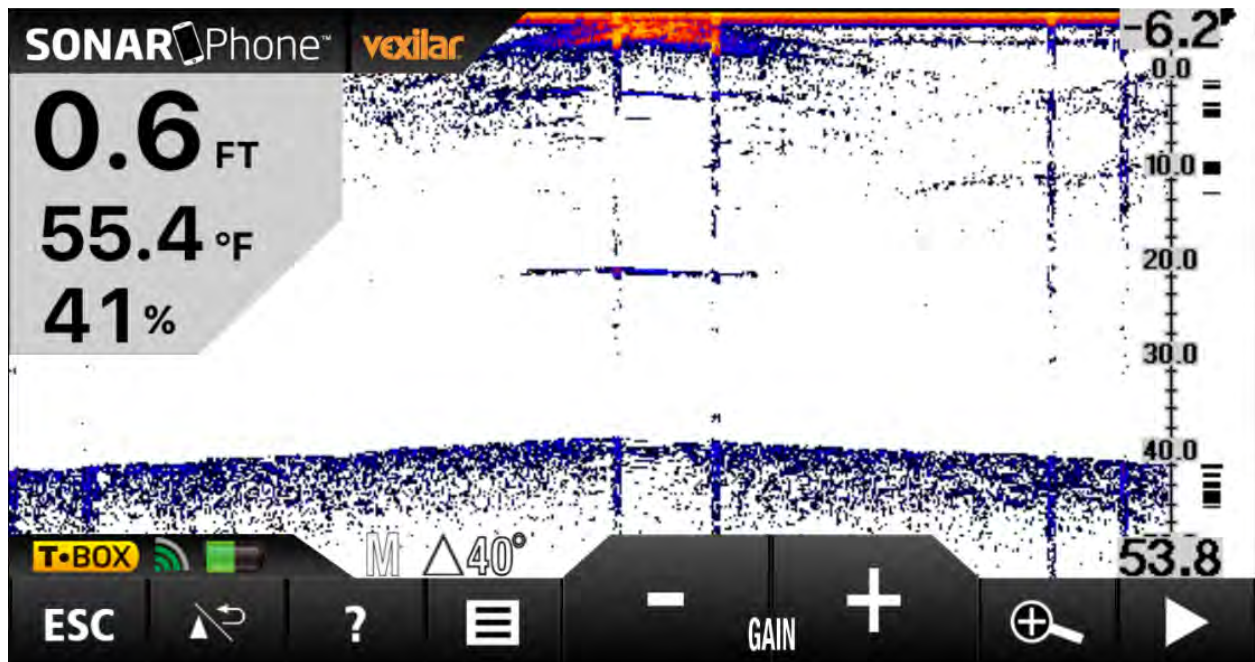

Figure 6.3: One of the control baseline measurements taken at the beginning of the experiment. No gear or ropes were in the water, and the return from the bottom is clean, at about 40-42 feet below the transducer, in turn at a depth of about 6 feet (46-48 feet water depth). Beamwidth is recorded as 40° (83kHz frequency), whereas all other recordings used a beamwidth of 20° (200kHz frequency).

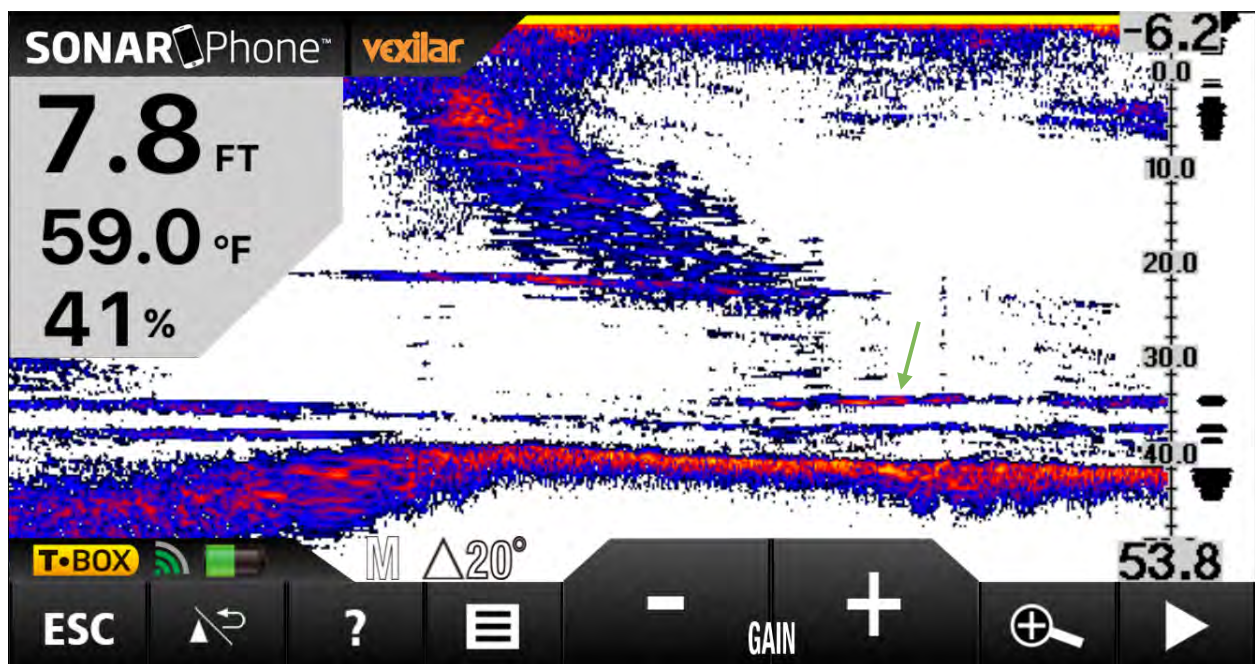

Figure 6.4: One of the echosounder recordings taken with the line pool at the bottom of the well. We interpret the strong returns around 6 feet off the bottom (green arrow) as likely being from the line pool, although that is not conclusive.

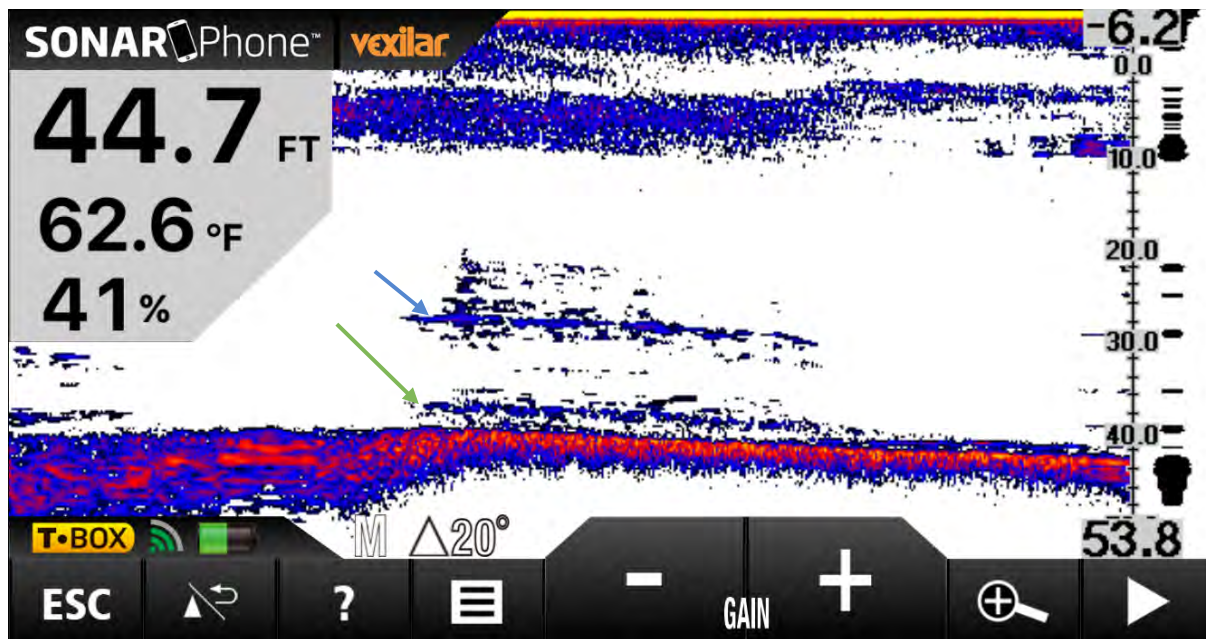

Figure 6.5: One of the echosounder recordings taking with the bare lobster trap with no reflectors at the bottom of the well (returns interpreted as bare trap indicated with green arrow). The vertical line from the crane and its hook and shackle are in the water column, and will contribute to the return signal (returns interpreted as the hook and shackle indicated with blue arrow).

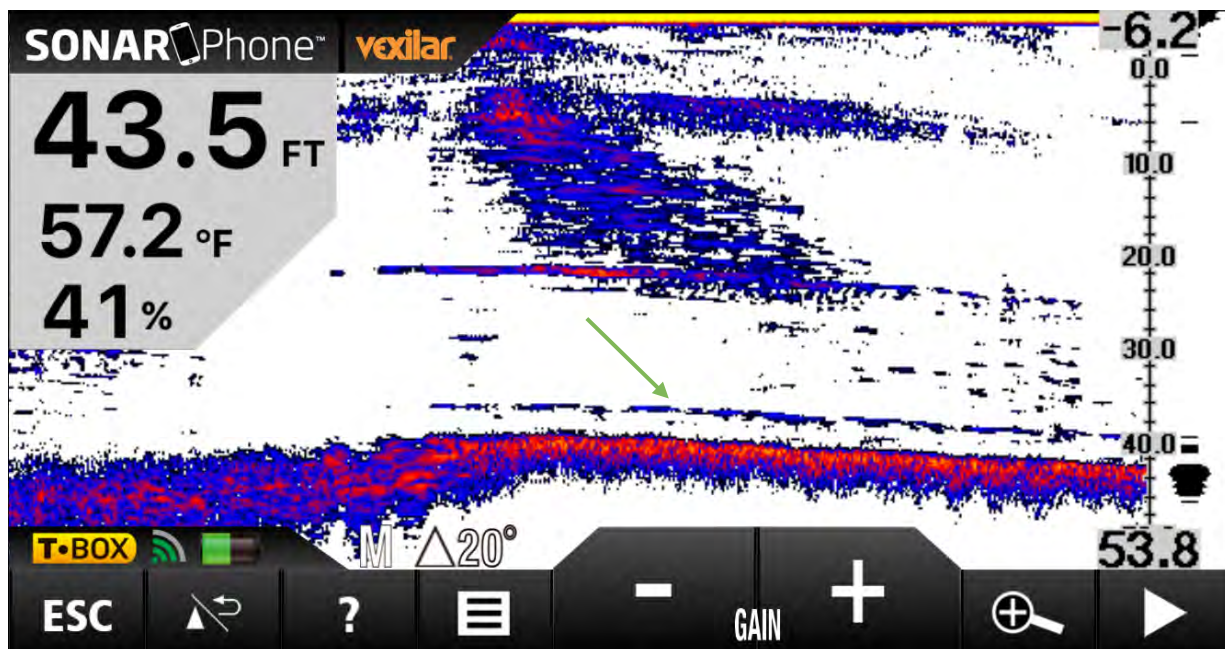

Figure 6.6: One of the echosounder recordings taken with the lobster trap with PVC pipe reflectors at the bottom of the well. The returns that are about 2 feet off the bottom (green arrow) are consistent with approximately where we would expect returns from the PVC pipes on top of the trap, but are not conclusive.

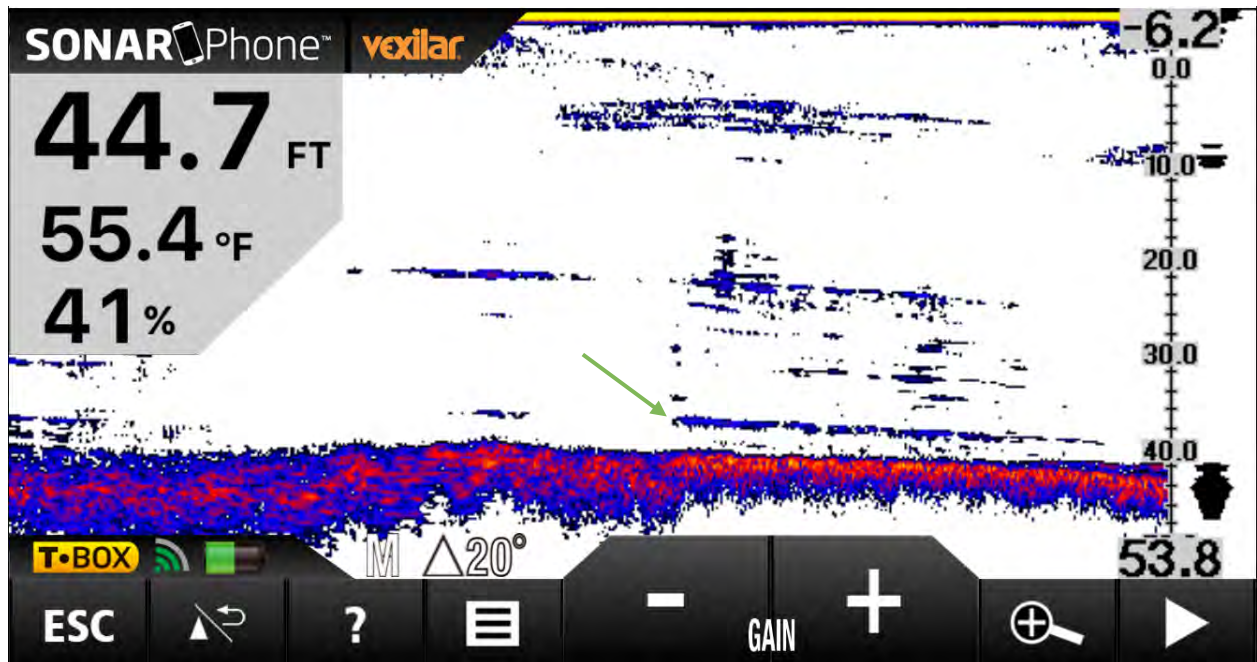

Figure 6.7: Echosounder recordings taken with the lobster trap with metal tube reflectors at the bottom of the well. The returns that are about 2 feet off the bottom are consistent with approximately where we would expect returns from the metal tubes on top of the trap (green arrow), but are not conclusive.

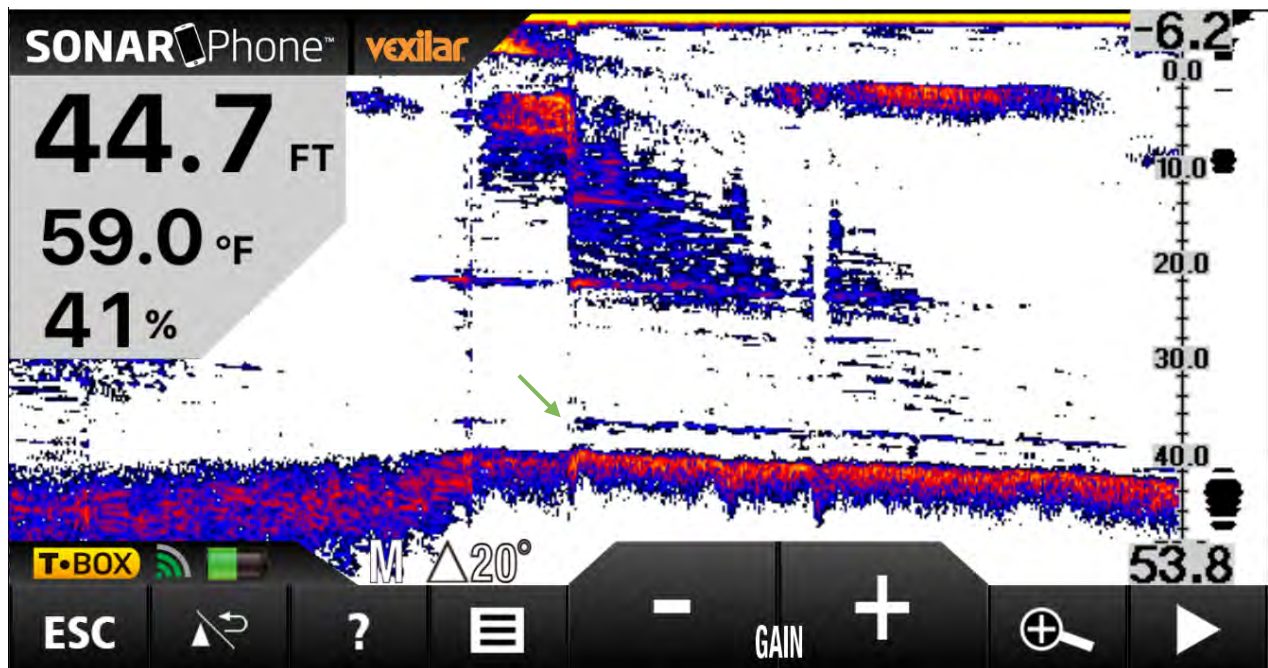

Figure 6.8: Echosounder recordings taken with the lobster trap with steel plate reflector at the bottom of the well. The returns that are about 2 feet off the bottom are consistent with approximately where we would expect returns from the steel plate on top of the trap (green arrow), but are not conclusive.

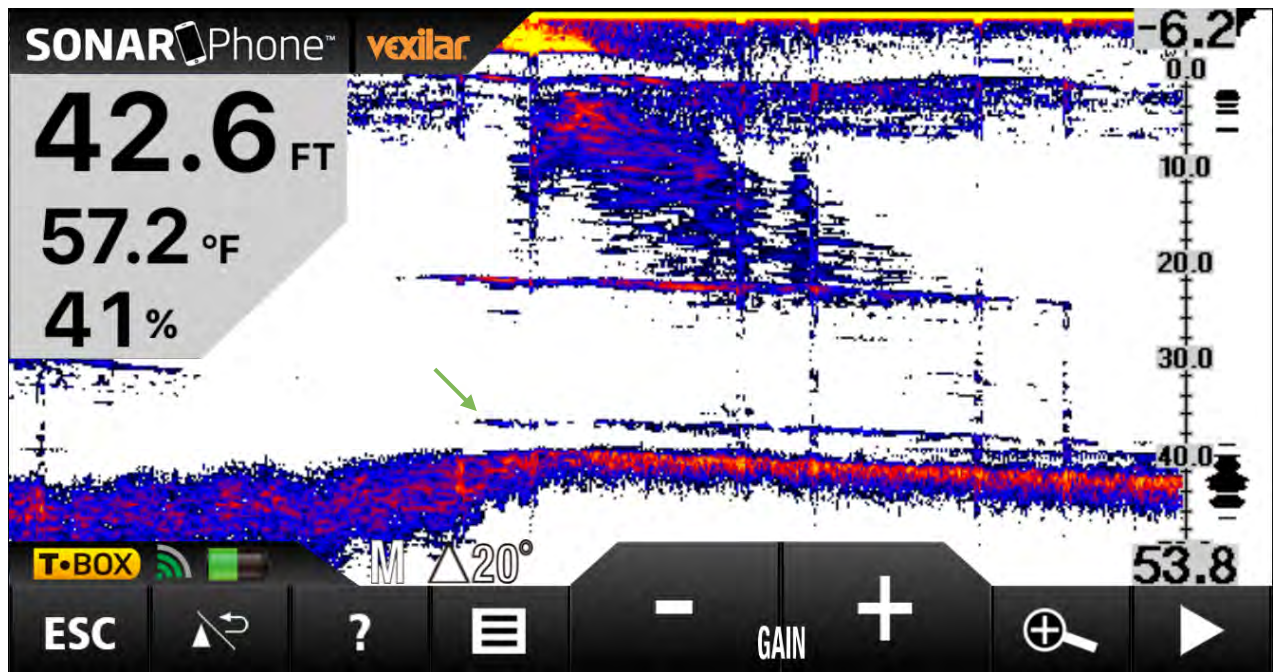

Figure 6.9: One of the echosounder recordings taken with the lobster trap with two trawl floats at the bottom of the well. The returns that are about 2 feet off the bottom are consistent with approximately where we would expect returns from the floats on top of the trap (green arrow), but are not conclusive.

As shown below in the caption for Figure 6.10, the control echosounder recordings made at the end of the experiment were very different from the control recordings at the end of the experiment. The recordings taken at the end of the experiment without any gear in the water show returns approximately where they would have been expected from reflectors placed on top of the lobster trap, so we cannot conclude that the experiments with acoustic reflectors definitively showed returns from the reflectors or from something else in the water, such as sediment, or fish feeding on sediment that may have been stirred up by the experiment.

The depth in the instrument-testing “well” section of the WHOI dock that we were able to use is about 45-50 feet (13-15m). It is difficult to extrapolate from a dock test in 13m of water to estimate passive detectability in 300 m of water, in particular because of the high resolution that would be required to distinguish a passive reflector about 50 cm above the seafloor (on top of a trap) from the seafloor itself. In addition, the width of the opening of the well on the WHOI dock is about 18 feet. With a 20° beamwidth, the echosounder beam at the bottom (45-50’ depth) is about the same as the width of the opening of the well, and so our experiments did not resolve the edges of the line spool or traps.

The resolution required to distinguish a passive reflector on top of a lobster trap that is 50 cm high from the seafloor is achievable for a perfect pencil-beam sonar – it is about 15-20 wavelengths at 50 kHz and requires a very achievable timing resolution of several hundred microseconds. But for a typical sonar, even with a narrow beamwidth of 10°, the beam’s “spot size” on the seafloor at 300 m depth is roughly 20 m in diameter. The surrounding seafloor would have to be flat enough that the 50 cm-high traps would be the highest point within several sonar spot sizes – meaning that there could not be any small mounds, rises, or medium-sized rocks. There’s a tradeoff of a narrow enough beam to be able to distinguish a target from the seafloor around it, but a wide enough beam so that the fishing vessel would not need to be directly on top of the trap to detect it acoustically.

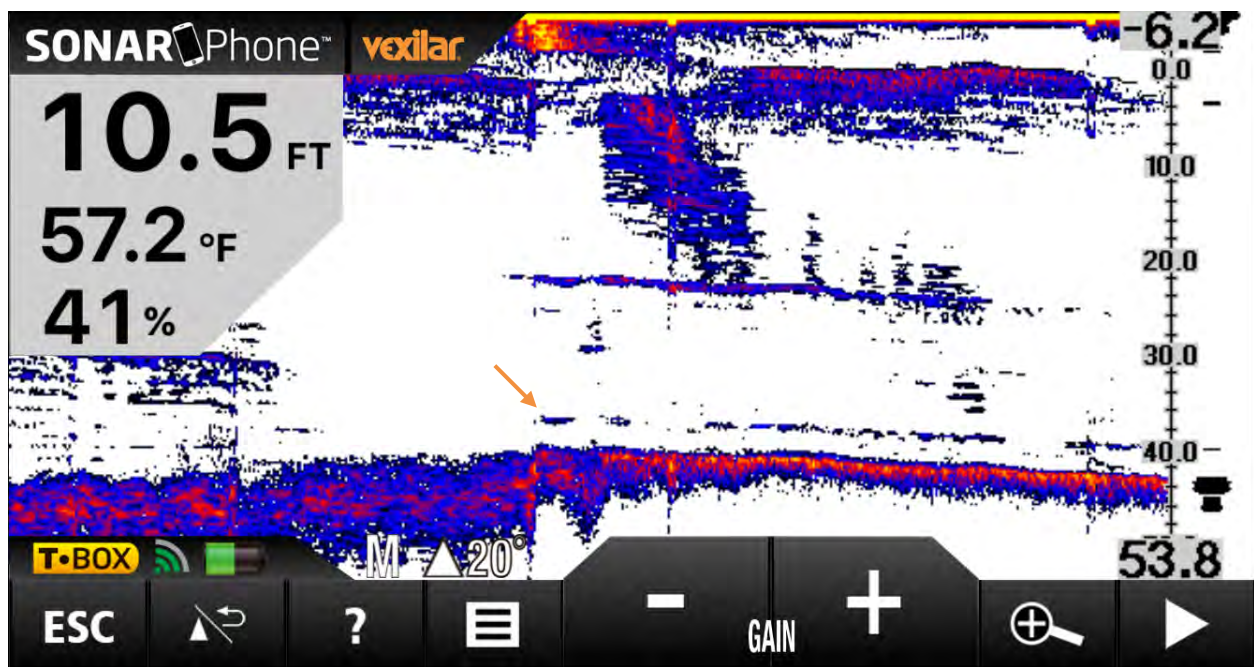

Figure 6.10: One of the control echosounder recordings taken at the end of the experiment with no gear or rope in the water aside from the towfish and transducer. The control recordings taken at the end of the experiment are very different from the control readings taken at the beginning of the experiment, in that there are significant returns at about 2 feet off the bottom (orange arrow). These control recording unfortunately invalidate any conclusions that could be drawn from the other experimental recordings with the lobster trap reflectors, making it impossible to determine from these results whether the experimental returns are due to the reflectors, or something else such as sediment stirred up by the lobster traps or fish attracted to something stirred up by the experiments, or to the difference in resolution and scattering strength between returns at 83kHz and 200kHz.

Based on this preliminary trial, subsequent evaluations of passive acoustic detectability should:

- Ensure that all measurements are made at the same frequency, and ideally repeat each experimental treatment at each frequency, 83 kHz and 200 kHz. Although the beamwidth is wider at 83 kHz than it is at 200 kHz, 83 kHz would be more representative of the frequency used in deep water. 200 kHz has the benefit of a (slightly) narrower beam as well as showing more structure (though also noise) in the water column.
- Perform control recordings with no gear in the water between every experimental treatment, rather than just at the beginning and end of the overall experiment. If the additional sonar returns were being caused by sediment stirred up in the water column, we would be able to tell more quickly, and perhaps determine the settling time required after each time the bottom is disturbed before a measurement can be made (i.e. make control recordings at both frequencies, deploy experimental treatment, determine time for needed for sediment to resettle, make experimental recordings at both frequencies, recover, determine time for needed for sediment to resettle, repeat).

Section 7: Conclusions and Future Work

Under the work described in this technical report, we have designed a prototype rope-less fishing system functionally appropriate for the challenging environment of the New England offshore lobster fishery. We have fabricated three prototype rope-less fishing units that can be further tested under at-sea conditions, including on board offshore lobster fishing boats. We want to emphasize that at this stage these units should not be considered commercially ready, but as a contribution to advancing the research into a system that might eventually be used in the Gulf of Maine or in other parts of the world to reduce whale entanglement risk while being practical for fishing. The first three prototypes were produced at a cost of approximately \$13,000 each. We believe that through design-for-manufacture and increased production numbers, that cost could come down significantly, but at this point we do not have a per-unit cost estimate under larger scale production.

The logical next step is to perform dock testing of the unit itself to verify that line unspooling is robust, and to characterize other performance factors. Following dock testing and subsequent design refinement to correct release issues and performance characterization, sea trials should be carried out from a research vessel to validate line spool unspooling in deeper water. These are the critical testing steps required before beginning a collaboration with fishermen and fishing industry associations to deploy the rope-less gear operationally and evaluate its potential in the fishery. Looking further ahead, at some point it might be helpful to establish a Gear Development Area in which an areas closed to lobster fishing might permit the testing of rope-less fishing systems such as this

one. This idea has been suggested within the ALWTRT (NMFS Concept Paper on ALWTRT, Nov. 2010).

We believe a timer-based system provides good cost-effectiveness to reduce exposure of animals to vertical lines in the water column, without requiring more expensive acoustic deck gear on fishing vessels. Furthermore, timer-based releases can allow the line to be at the surface when the fishing vessel arrives on site, saving time by not having to wait for the system to float to the surface (on the order of 10 minutes acoustically summoned in 300m of water depth). Nevertheless, we do not rule out that an acoustic release might be eventually preferable given the better on-site timing of gear retrieval that it provides for fishermen. Our system design includes provisions for straightforward integration of an acoustic modem and transducer, and the existing microcontroller board has the hardware capability (but not yet the software) to perform as a relatively simple low-cost, low-power acoustic modem.

Another reason to include active acoustics capability is that we believe it will be difficult to detect passive acoustic reflectors on lobster traps on the seafloor at 300m depth. Our preliminary dock experiment, however, did not conclusively prove this point, and if acoustic deck gear remains prohibitively expensive, passive acoustic experiments will need to be revisited. To reduce gear conflicts with rope-less fishing trawls, an active acoustic query from fishing vessels may be the best solution, with a reply from the rope-less system on the seafloor indicating that gear has been set in that location. If acoustic deck gear were acquired among fishing fleets operating in the same area, the acoustic reply from the rope-less system can be integrated into displays, for example by showing the location, length, and compass heading (but not owner's name) of a trawl, to reduce gear conflicts.

To minimize the time required at sea to redeploy gear, we have propose consideration of an onshore re-spooling industry, providing pre-spooled line cartridges that fishermen can rapidly install onto an empty line spool. There are a number of technical hurdles to this idea, including that a large volume of line would be difficult to store on many fishing vessels, which argues for an onboard re-spooling machine rather than an onshore service industry. If the minimum line diameter allowable can be reduced from 1/2" to perhaps 3/8", design requirements would be eased significantly, allowing a smaller system with a lower buoyancy requirement, and easier storage of pre-spooled line cartridges.

After future dock testing and research vessel sea trials are performed, the three existing prototypes will be available for operational testing in collaboration with fishermen. The prototype designs all exist as electronic design files, and additional prototype units can be fabricated as required. The ultimate goal of this research project is to enable evaluation of the potential of rope-less fishing for the offshore lobster fishery in the Gulf of Maine.

Acknowledgements

This investigation was supported by The Consortium for Wildlife Bycatch Reduction at the New England Aquarium under NOAA / NMFS Grant Award NA10NMF4520343.

Tim Werner from New England Aquarium was an integral partner on this project, providing guidance on the higher-level managerial decisions, in particular for us to focus on the offshore lobster fishery due to its heavier gear that poses a larger risk to entangled animals as well as the lack of other entanglement mitigation approaches for the offshore fishery.

Lori Caron, Denny Colbert, and Rob Martin were extremely generous with their time during our visits to their fishing vessels and follow-up questions by email and phone. Jeffrey Brodeur of Woods Hole Sea Grant was very helpful in providing additional background for the Gulf of Maine lobster fishery. Lee Freitag provided valuable technical and project management advice. Jeffrey Brodeur and Andy Girard lent us gear for the dock test evaluations. Robin Littlefield, Jim Dunn, John Kemp, Ben Allen, and Bob McCabe provided advice, ideas, and cautions from their cumulative decades of experience with various release mechanisms and line packs. Tom Austin recommended pursuing a timer-based release for the prototype units as a cost-effective alternative to an acoustic release. Eric Gallimore provided feedback on the circuit designs. Michael Moore provided references to the previously suggested Gear Development Area for rope-less fishing gear. Alex Bocconcelli and Tom Hurst, as well as Tom Austin and Ben Allen, provided ideas and feedback in early meetings with Tim Werner.

References

Allen, R.B., and DeAlteris, J. 2007. Use of pop-up buoys in fixed gear commercial fisheries: a demonstration. National Fish and Wildlife Foundation Project No.2005-0327-002, Wash.DC, 21pp

DeAlteris, J. 1999. Design, testing and evaluation of an acoustic release system for offshore lobster pot buoy lines. NMFS Project No. 40EANF800065, submitted to Al Blot of the NMFS Fisheries Engineering Group, Kingston, RI, 16pp.

FioBuoy, FioMarine, Australia. <http://www.fiomarine.com/fiobuoyrange.html>

Freitag, L., M. Grund, J. Partan, S. Singh, P. Koski, K. Ball. 2005. "The WHOI Micro-Modem: An Acoustic Communications and Navigation system for Multiple Platforms", Proc. IEEE Oceans.

Gallimore, E., J.Partan, I.Vaughn, S.Singh, J.Shusta, L.Freitag. 2010 The WHOI Micromodem-2: A Scalable System for Acoustic Communications and Networking. Proc. IEEE Oceans 2010.

Gobat, J., and Grosenbaugh, M. 2000. WHOI Cable v2.0: Time Domain Numerical Simulation of Moored and Towed Oceanographic Systems, Woods Hole Oceanographic Institution, Technical Report WHOI-2000-08. <http://iop.apl.washington.edu/~jgobat/cable.pdf>

Hopkins, N. and Hoggard, W. 2006. A pilot study to investigate possible alternatives to reducing Vertical line entanglements by marine mammals. Report by the Harvesting Systems Gear Team of NOAA's Southeast Fisheries Science Center. In: Salvador, G., J. Kenney, and J. Higgins (eds), Large Whale Gear Research Summary, NOAA/Fisheries Northeast Regional Office (NERO), Protected Resources Division (PRD), Gear Research Group, December, 2006.

Knowlton, A.R., Robbins, J., Landry, S., McKenna, H.A., Kraus, S.D., and Werner, T.B. 2015 (*in press*). Implications of fishing rope strength on the severity of large whale entanglements. Conservation Biology.

Liggins, G., and S. Westley. 2011. "Acoustic release technology: Application in lobster fisheries: the New South Wales Experience", Powerpoint presentation, 24pp.

McCarron, P., and H. Tetreault, 2012. Lobster Pot Gear Configurations in the Gulf of Maine. Consortium for Wildlife Bycatch Reduction, 36 pp.
http://www.bycatch.org/sites/default/files/Lobster_Gear_Report_0.pdf

NMFS Concept Paper on ALWTRT, Nov 2010. Proposal to Open a Management Area Presently Closed to Trap/Pot Fisheries to Stimulate Development of Ropeless [Buoy Lineless] Fishing.
http://www.greateratlantic.fisheries.noaa.gov/whaletrp/trt/meetings/Mid-Atlantic_Southeast_ALWTRT_Materials/Final%20Lineless%20Concept%20Paper%20Nov2010.pdf

Sub Sea Sonics, <http://subseasonics.com/>

Turner, H., DeCrew, J., Goldsmith, D., and Brimlow, S. 1999. BLT: acoustically triggered Buoyless Lobster Trap recovery system. University of New Hampshire/University of Maine Sea Grant, 89pp.